



# 幼兒桌椅系列

**LITTON** 利通貿易工程有限公司  
LITTON TRADING & ENGINEERING LTD.

澳門宋玉生廣場, 258 建興龍廣場, 22樓H

ALAMEDA DR CARLOS D'ASSUMPCAO, 258, KIN HENG LONG PLAZA, 22H, Macau

Tel:2870 1830 Fax:2870 1630 E-mail: [info@kamslitton.com](mailto:info@kamslitton.com)

[www.kamslitton.com](http://www.kamslitton.com)

型号 Item#:

# 可拼式幼儿半月桌 LTY - 893

Combined kis's half-moon table

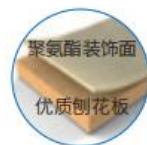

面板特殊定制



全面升级 E0 级刨花板



板材可降解

包边颜色:

Edge color.



桌面颜色:

Table top color.

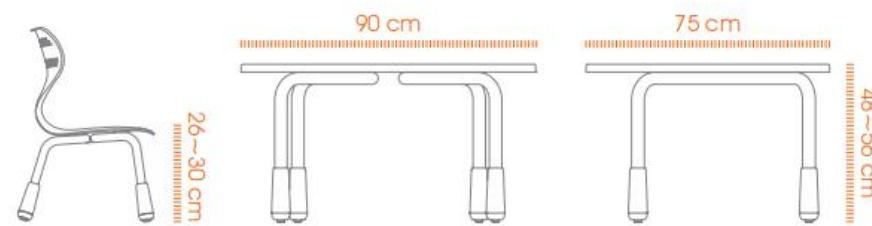

型号 Item#	桌面规格: cm Specification of desktop.	高度: cm The height of desktop.	桌面材料 Tabletop material.
LTY - 893	95x75	48~56	刨花板、注塑包边
LTX - 801 椅子		26~32	PP

LITTON

利通貿易工程有限公司

LITTON TRADING & ENGINEERING LTD.

澳門宋玉生廣場, 258 建興龍廣場, 22樓H

ALAMEDA DR CARLOS D'ASSUMPCAO, 258, KIN HENG LONG PLAZA, 22H, Macau

Tel:2870 1830 Fax:2870 1630 E-mail: [info@kamslitton.com](mailto:info@kamslitton.com)

[www.kamslitton.com](http://www.kamslitton.com)

型号 Item#:

# 可拼式长方桌 LTY - 861

Combined kid's rectangular table

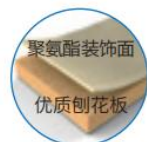

面板特殊定制



全面升级 E0 级刨花板



板材可降解

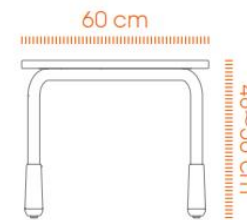
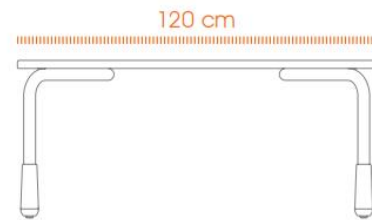

包边颜色:  
Edge color.



桌面颜色:  
Table top color.



型号 Item#	桌面规格: cm Specification of desktop.	高度: cm The height of desktop.	桌面材料 Tabletop material.
LTY - 861	115x60	48~56	刨花板、注塑包边
LTX - 801 椅子		26~32	PP

型号 Item#:

# 可拼式箭头桌 LTY - 819

Combined arrow table

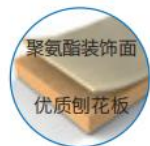

聚氨酯装饰面  
优质刨花板



全面升级 E0 级刨花板



板材可降解

包边颜色:

Edge color.



桌面颜色:

Table top color.

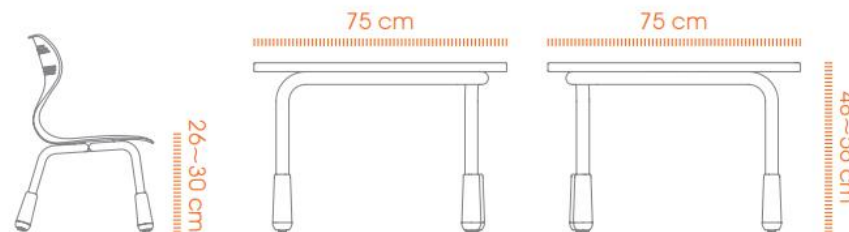

型号 Item#

桌面规格: cm

Specification of desktop.

高度: cm

The height of desktop.

桌面材料

Tabletop material.

LTY - 819

75x75

48~56

刨花板、注塑包边

LTX - 801 椅子

26~32

PP

LITTON

利通貿易工程有限公司

LITTON TRADING & ENGINEERING LTD.

澳門宋玉生廣場, 258 建興龍廣場, 22樓H

ALAMEDA DR CARLOS D'ASSUMPCAO, 258, KIN HENG LONG PLAZA, 22H, Macau

Tel:2870 1830 Fax:2870 1630 E-mail: [info@kamslitton.com](mailto:info@kamslitton.com)

[www.kamslitton.com](http://www.kamslitton.com)

型号 Item#:  
**可拼式梯形桌 LTY - 891**  
 Combined triangle table

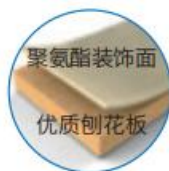

面板特殊定制



全面升级 E0 级刨花板



板材可降解

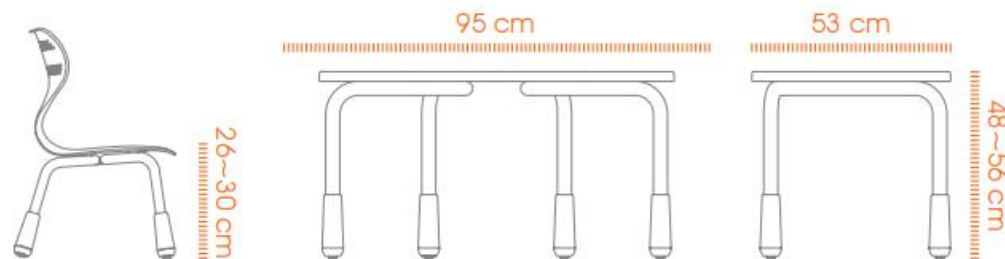

包边颜色:  
Edge color.



桌面颜色:  
Table top color.



型号 Item#	桌面规格: cm Specification of desktop.	高度: cm The height of desktop.	桌面材料 Tabletop material.
LTY - 891	95x53	48~56	刨花板、注塑包边
LTX - 801 椅子		26~32	PP

型号 Item#:  
**可拼式正方桌 LTY - 871**  
 Combined Square Table

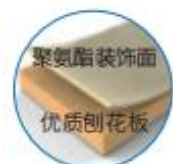

面板特殊定制



全面升级 E0 级刨花板



板材可降解



26~30 cm

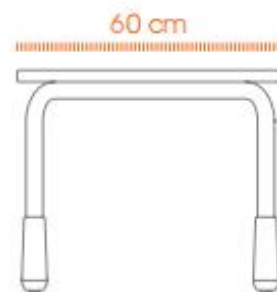

60 cm

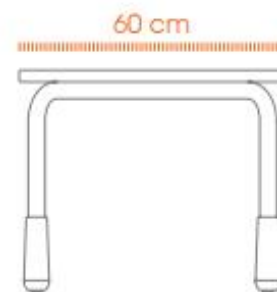

60 cm

48~56 cm

包边颜色:  
Edge color.



桌面颜色:  
Table top color.

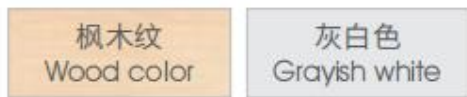

型号 Item#	桌面规格: cm Specification of desktop.	高度: cm The height of desktop.	桌面材料 Tabletop material.
LTY - 871	60x60	48~56	刨花板、注塑包边
LTX - 801 椅子		26~32	PP

型号 Item#: **豪华正方桌 LTY - 011**  
Square Table

橙黄色 Orange



宝蓝色 Royal blue



自由组合:  
Free combination.

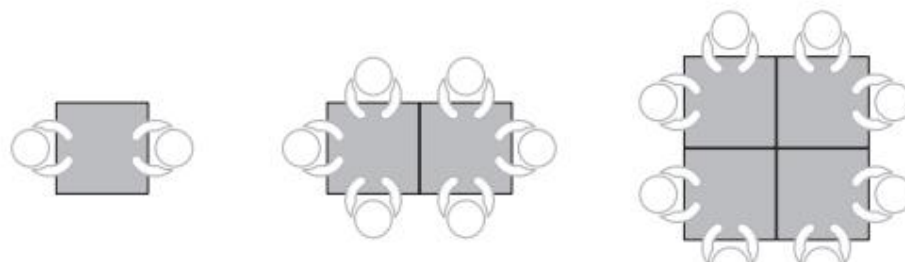

红色 Red



桌脚升降高度:  
Table foot lifting height.

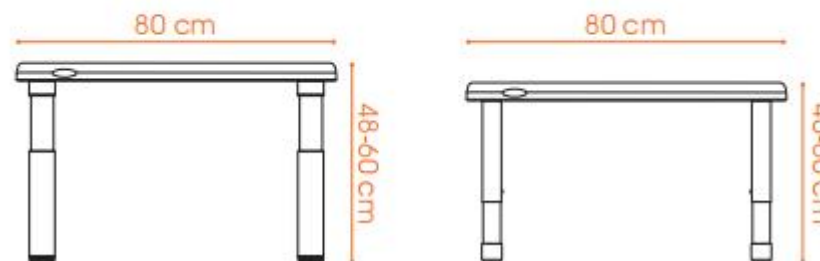

型号 Item#

桌面规格: cm  
Specification of desktop

高度: cm  
The height of desktop

桌面材料  
Tabletop material.

LTY - 011

80x80

40-60

中空吹塑  
Blow mould

LTY - 011-1

80x80

48-60

型号 Item#:

# 豪华长方桌 LTY - 012

Rectangle table

宝蓝色 Royal blue



蓝色 Blue



自由组合:  
Free combination.

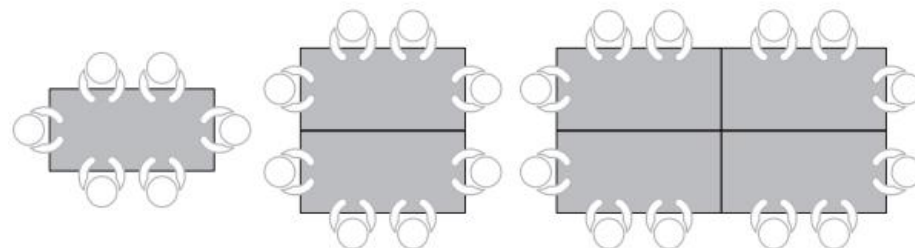

果绿色 Peak green



LTY - 012-1

LTY - 012



桌脚升降高度:  
Table foot lifting height.

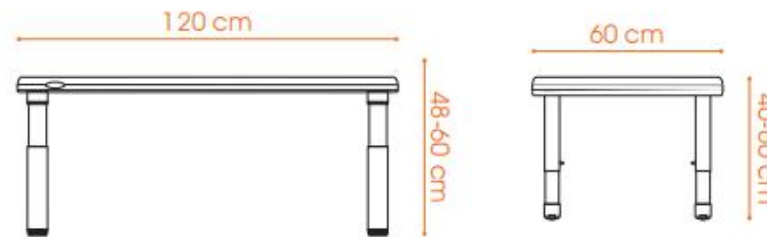

型号 Item#

桌面规格: cm  
Specification of desktop

高度: cm  
The height of desktop

桌面材料  
Tabletop material.

LTY - 012

120x60

40-60

中空吹塑

LTY - 012-1

120x60

48-60

Blow mould



型号 Item#:  
**豪华圆桌 LTY - 068**  
 Round table

橙黄色 Orange



红色 Red



桌脚升降高度:  
 Table foot lifting height.

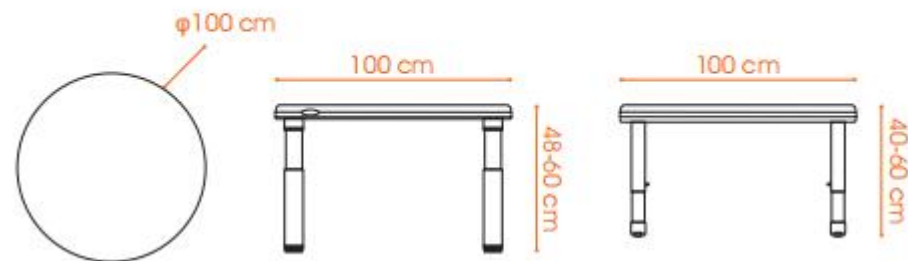

绿色 Green



宝蓝色 Royal blue

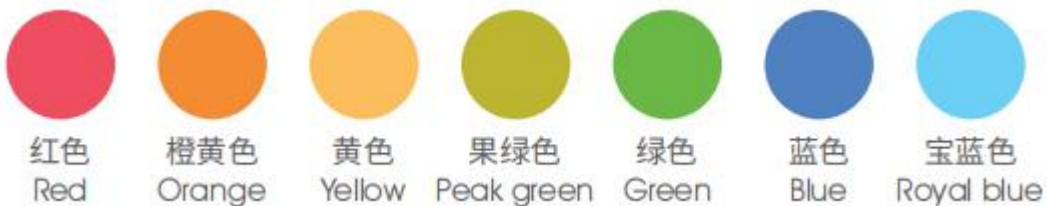

型号 Item#	桌面规格: cm Specification of desktop	高度: cm The height of desktop	桌面材料 Tabletop material.
LTY - 068	Φ100	40-60	中空吹塑 Blow mould
LTY - 068-1	Φ100	48-60	

型号 Item#:

# 幼儿经典长方桌 LTY - 083

Classic rectangular table for children

红色 Red



黄色 Yellow



蓝色 Blue



绿色 Green



桌脚升降高度:  
Table foot lifting height.

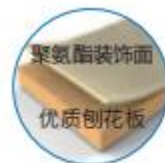

面板特殊定制

全面升级 E0 级刨花板

板材可降解



红色 Red

橙黄色 Orange

黄色 Yellow

果绿色 Peak green

绿色 Green

蓝色 Blue

型号 Item#	桌面规格: cm Specification of desktop	高度: cm The height of desktop	桌面材料 Tabletop material.
LTY - 083	120x60	46-58	哑光桌面不可书写
LTY - 083-C	120x60	46-58	光亮桌面可擦写

LITTON

利通貿易工程有限公司

LITTON TRADING & ENGINEERING LTD.

澳門宋玉生廣場, 258 建興龍廣場, 22樓H

ALAMEDA DR CARLOS D'ASSUMPCAO, 258, KIN HENG LONG PLAZA, 22H, Macau

Tel:2870 1830 Fax:2870 1630 E-mail: [info@kamslitton.com](mailto:info@kamslitton.com)

[www.kamslitton.com](http://www.kamslitton.com)

型号 Item#:

# 幼儿经典正方桌 LTY - 084-C

Children's classic square table

蓝色 Blue



红色 Red



黄色 Yellow



橙黄色 Orange



桌脚升降高度:  
Table foot lifting height.

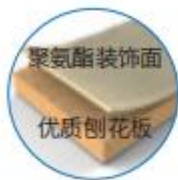

面板特殊定制



全面升级 E0 级刨花板



板材可降解



红色 Red



橙黄色 Orange



黄色 Yellow



果绿色 Peak green



绿色 Green



蓝色 Blue

型号 Item#

桌面规格: cm  
Specification of desktop

高度: cm  
The height of desktop

桌面材料  
Tabletop material.

LTY - 084

60x60

46-58

哑光桌面不可书写

LTY - 084-C

60x60

46-58

光亮桌面可擦写

LITTON

利通貿易工程有限公司

LITTON TRADING & ENGINEERING LTD.

澳門宋玉生廣場, 258 建興龍廣場, 22樓H

ALAMEDA DR CARLOS D'ASSUMPCAO, 258, KIN HENG LONG PLAZA, 22H, Macau

Tel:2870 1830 Fax:2870 1630 E-mail: [info@kamslitton.com](mailto:info@kamslitton.com)

[www.kamslitton.com](http://www.kamslitton.com)

型号 Item#:

# 可拼式箭头桌 LTY - 019

Combined arrow table

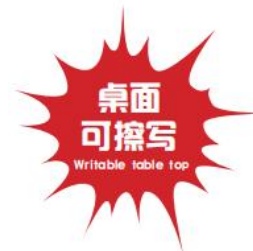

## 包边颜色:

Edge color

红色 Red	橙黄色 Orange	黄色 Yellow	
果绿色 Peak green	绿色 Green	蓝色 Blue	米黄色 Beige color

## 桌面颜色:

Table top color

枫木纹 Wood color	白色 White
-------------------	-------------

## 桌脚升降高度:

Table foot lifting height.

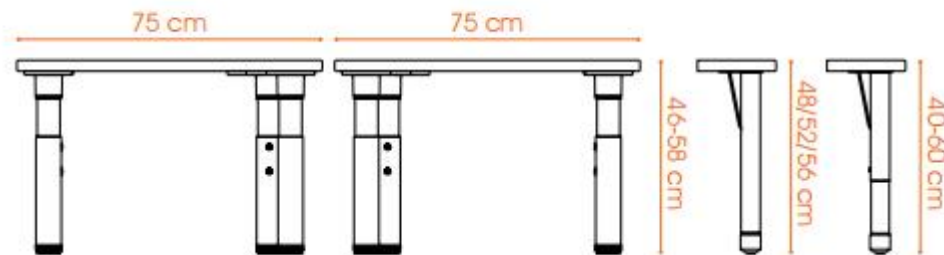

型号 Item#	桌面规格: cm Specification of desktop	高度: cm The height of desktop	桌面材料 Tabletop material.
LTY - 019	75x75	40-60	
LTY - 019-1-48	75x75	48	刨花板、注塑包边 Particle board Injection binging
LTY - 019-1-52	75x75	52	
LTY - 019-1-56	75x75	56	
LTY - 019-2	75x75	46-58	

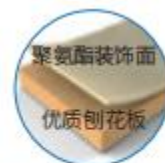

面板特殊定制



全面升级 E0 级刨花板



板材可降解

型号 Item#:

# 可拼式三角桌 LTY - 072

Combined triangle table

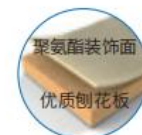

面板特殊定制 全面升级 E0 级刨花板 板材可降解

桌脚升降高度:

Table foot lifting height.

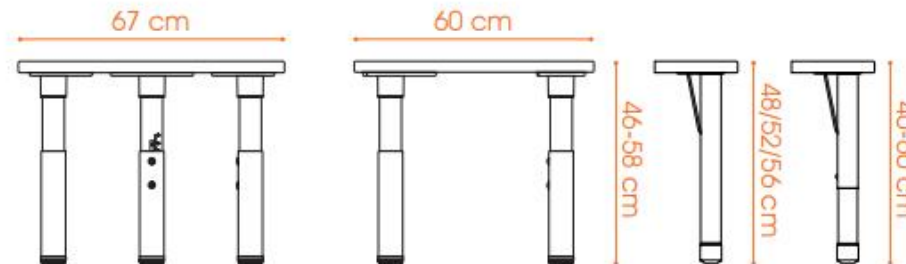

自由组合:

Free combination.



包边颜色:

Edge color

红色 Red	橙黄色 Orange	黄色 Yellow	
果绿色 Peak green	绿色 Green	蓝色 Blue	米黄色 Beige color

桌面颜色:

Table top color

枫木纹 Wood color	白色 White
-------------------	-------------



型号 Item#	桌面规格: cm Specification of desktop	高度: cm The height of desktop	桌面材料 Tabletop material.
LTY - 072	67x60	40-60	
LTY - 072-1-48	67x60	48	
LTY - 072-1-52	67x60	52	
LTY - 072-1-56	67x60	56	
LTY - 072-2	67x60	46-58	刨花板、注塑包边 Particle board Injection binging

型号 Item#:

# 可拼式皂形桌 LTY - 098

Combined soap table



自由组合:  
Free combination.

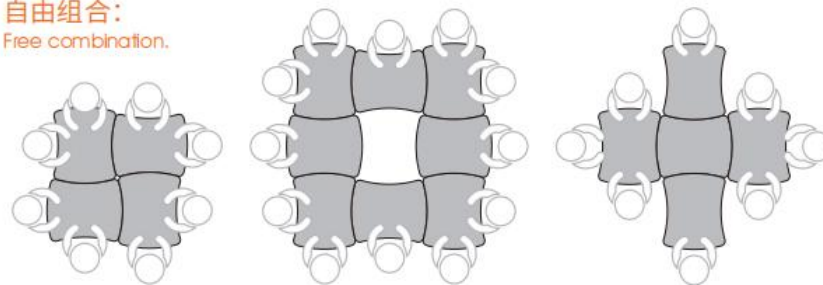

桌脚升降高度:  
Table foot lifting height.

桌面材料: 刨花板、注塑包边  
Tabletop material.

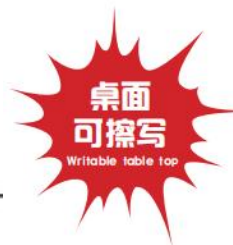

包边颜色:  
Edge color



桌面颜色:  
Table top color

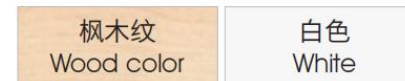

型号 Item#	桌面规格: cm Specification of desktop	高度: cm The height of desktop	桌面材料 Tabletop material.
LTY - 098	67x55	40-60	
LTY - 098-1-48	67x55	48	
LTY - 098-1-52	67x55	52	
LTY - 098-1-56	67x55	56	
LTY - 098-2	67x55	46-58	刨花板、注塑包边 Particle board Injection binging

LITTON

利通貿易工程有限公司

LITTON TRADING & ENGINEERING LTD.

澳門宋玉生廣場, 258 建興龍廣場, 22樓H

ALAMEDA DR CARLOS D'ASSUMPCAO, 258, KIN HENG LONG PLAZA, 22H, Macau

Tel:2870 1830 Fax:2870 1630 E-mail: [info@kamslitton.com](mailto:info@kamslitton.com)

[www.kamslitton.com](http://www.kamslitton.com)

型号 Item#:

# 梅花形游戏桌 LTY - 073

Plum flower table

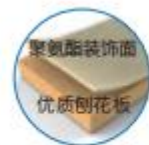

面板特殊定制 全面升级 E0 级刨花板 板材可降解

桌脚升降高度:  
Table foot lifting height.

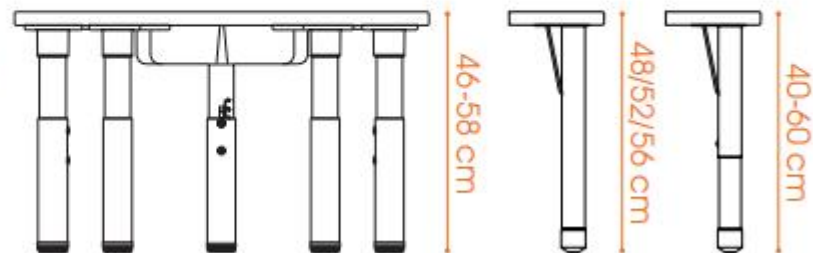
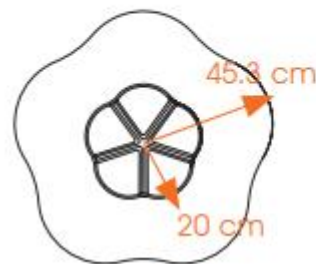

## 包边颜色:

Edge color



## 桌面颜色:

Table top color



型号 Item#

桌面规格: cm

Specification of desktop

高度: cm

The height of desktop

桌面材料

Tabletop material.

LTY - 073

R=45.3

40-60

LTY - 073-1-48

R=45.3

48

LTY - 073-1-52

R=45.3

52

LTY - 073-1-56

R=45.3

56

LTY - 073-2

R=45.3

46-58

刨花板、注塑包边

Particle board  
Injection molding

LITTON

利通貿易工程有限公司

LITTON TRADING & ENGINEERING LTD.

澳门木玉生廣場, 258 建興龍廣場, 22樓H

ALAMEDA DR CARLOS D'ASSUMPCAO, 258, KIN HENG LONG PLAZA, 22H, Macau

Tel:2870 1830 Fax:2870 1630 E-mail: [info@kamslitton.com](mailto:info@kamslitton.com)

[www.kamslitton.com](http://www.kamslitton.com)

型号 Item#:

# 梅花形游戏桌 LTY - 074

Plum flower table

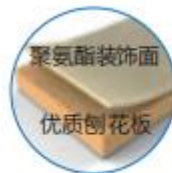

面板特殊定制



全面升级 E0 级刨花板



板材可降解



桌脚升降高度:

Table foot lifting height.

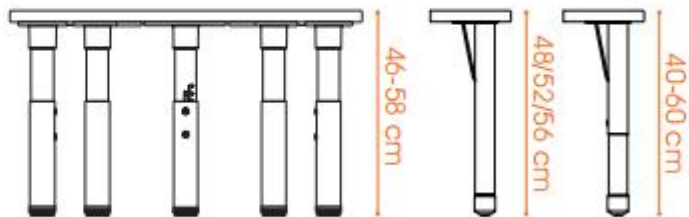
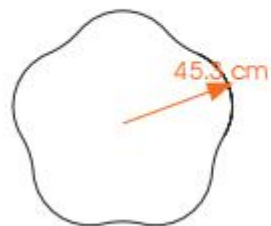

包边颜色:

Edge color



桌面颜色:

Table top color

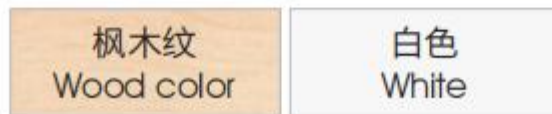

型号 Item#	桌面规格: cm Specification of desktop	高度: cm The height of desktop	桌面材料 Tabletop material.
LTY - 074	R=45.3	40-60	
LTY - 074-1-48	R=45.3	48	刨花板、注塑包边
LTY - 074-1-52	R=45.3	52	Particle board Injection binging
LTY - 074-1-56	R=45.3	56	
LTY - 074-2	R=45.3	46-58	



型号 Item#:

# 可拼式三叶草桌 LTY - 075

Combined three leaf table

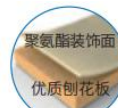

面板特殊定制 全面升级 E0 级刨花板 板材可降解

桌脚升降高度:

Table foot lifting height.

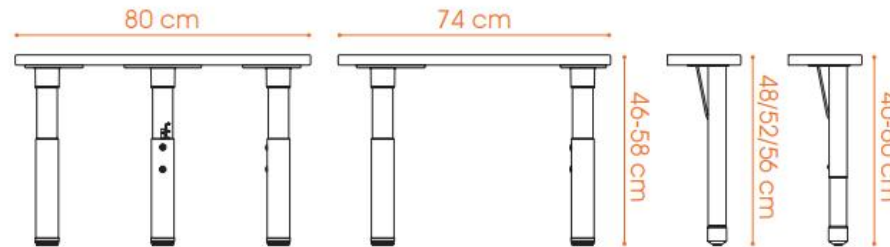

自由组合:

Free combination.

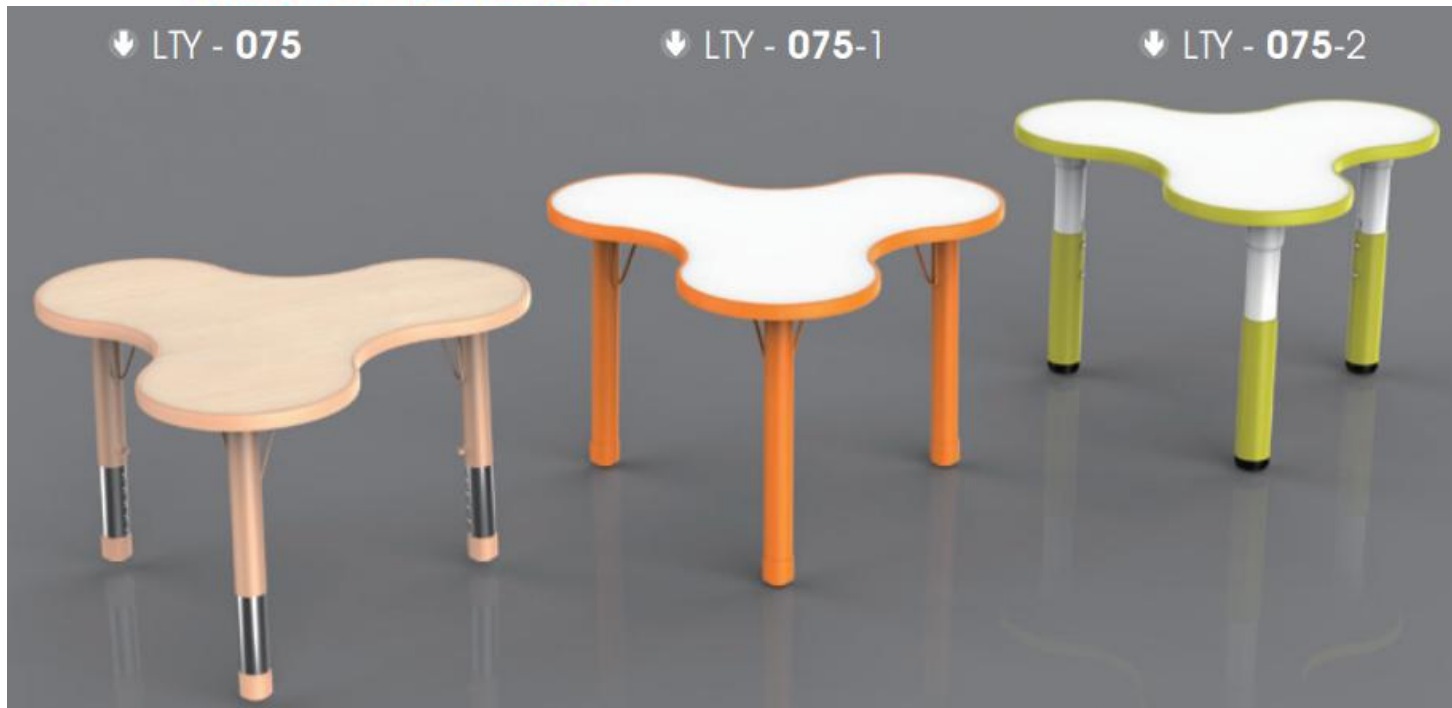
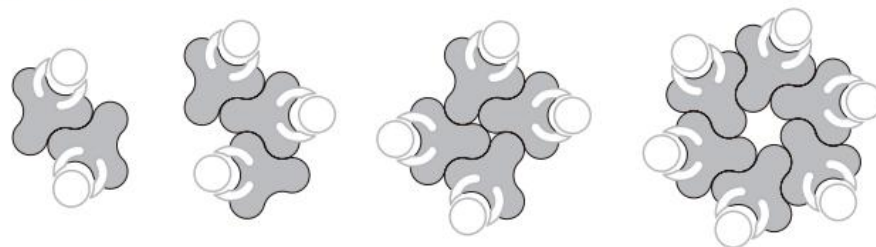

包边颜色:

Edge color

红色 Red	橙黄色 Orange	黄色 Yellow	
果绿色 Peak green	绿色 Green	蓝色 Blue	米黄色 Beige color

桌面颜色:

Table top color

枫木纹 Wood color	白色 White
-------------------	-------------

型号 Item#	桌面规格: cm Specification of desktop	高度: cm The height of desktop	桌面材料 Tabletop material.
LTY - 075	74x80	40-60	
LTY - 075-1-48	74x80	48	刨花板、注塑包边
LTY - 075-1-52	74x80	52	Particle board Injection binging
LTY - 075-1-56	74x80	56	
LTY - 075-2	74x80	46-58	



型号 Item#:

# 可拼式梯形桌 LTY - 091

Combined trapezoidal table

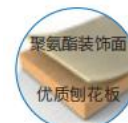

桌脚升降高度:

Table foot lifting height.

面板特殊定制 全面升级 E0 级刨花板 板材可降解

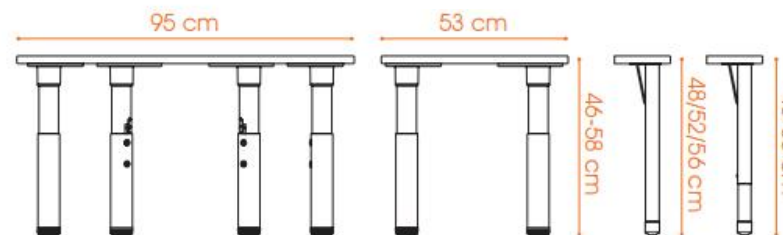

自由组合:

Free combination.

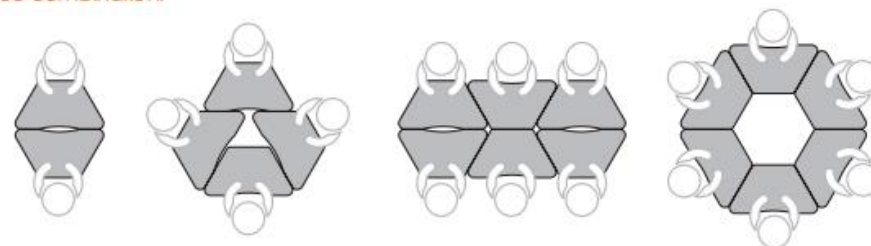

包边颜色:

Edge color

红色 Red	橙黄色 Orange	黄色 Yellow	
果绿色 Peak green	绿色 Green	蓝色 Blue	米黄色 Beige color

桌面颜色:

Table top color

枫木纹 Wood color	白色 White
-------------------	-------------



型号 Item#	桌面规格: cm Specification of desktop	高度: cm The height of desktop	桌面材料 Tabletop material.
LTY - 091	95x53	40-60	
LTY - 091-1-48	95x53	48	刨花板、注塑包边
LTY - 091-1-52	95x53	52	Particle board Injection binging
LTY - 091-1-56	95x53	56	
LTY - 091-2	95x53	46-58	
桌斗	95x53	10	

型号 Item#:

# 可拼式圆桌 LTY - 093

Combined circle table



自由组合:  
Free combination.

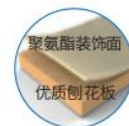

面板特殊定制 全面升级 E0 级刨花板 板材可降解



桌脚升降高度:  
Table foot lifting height.

桌面材料: 刨花板、注塑包边  
Tabletop material.

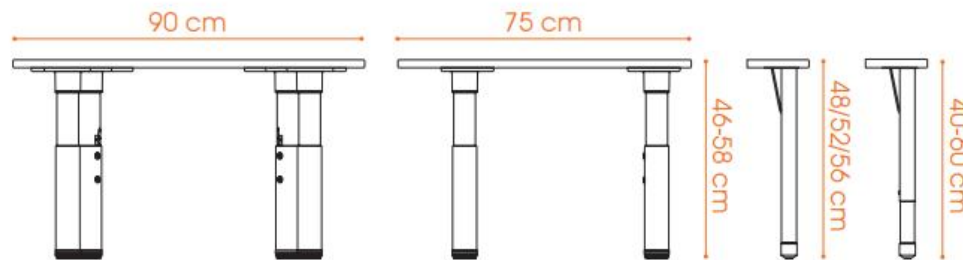

## 包边颜色:

Edge color



## 桌面颜色:

Table top color

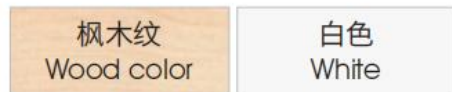

型号 Item#	桌面规格: cm Specification of desktop	高度: cm The height of desktop	桌面材料 Tabletop material.
LTY - 093	90x75	40-60	
LTY - 093-1-48	90x75	48	刨花板、注塑包边
LTY - 093-1-52	90x75	52	Particle board Injection bonding
LTY - 093-1-56	90x75	56	
LTY - 093-2	90x75	46-58	

型号 Item#: **豪华型幼儿月亮桌 LTY - 070**  
Luxury Kindergarten Half moon Table



包边颜色:  
Edge color



桌面颜色:  
Table top color



自由组合:  
Free combination.

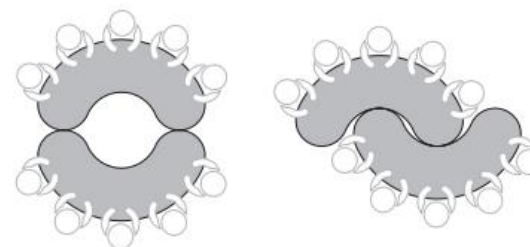

型号 Item#	桌面规格: cm Specification of desktop	高度: cm The height of desktop	桌面材料 Tabletop material.
LTY - 070	154x84	40-60	
LTY - 070	154x84	40-60	
LTY - 070-1-48	154x84	48	
LTY - 070-1-52	154x84	52	
LTY - 070-1-56	154x84	56	
LTY - 070-2	154x84	46-58	刨花板、注塑包边 Particle board, injection molding



桌脚升降高度:  
Table foot lifting height.

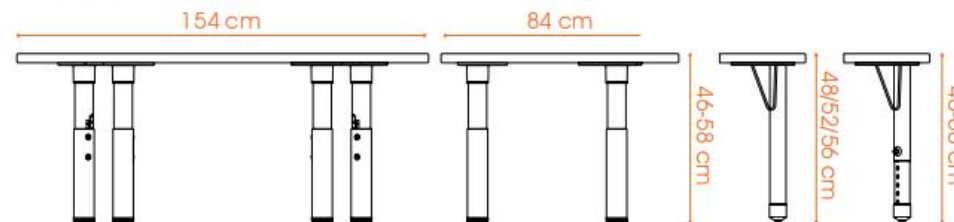

型号 Item#:

# 可拼式兒童半圓桌 LTY - 195

Luxury Kindergarten Half moon Table

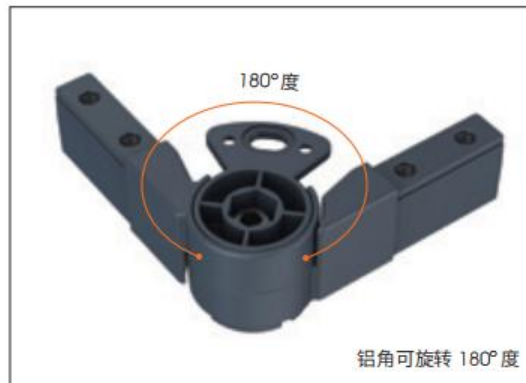

可组合成不同的形状  
Could be combined into different shape

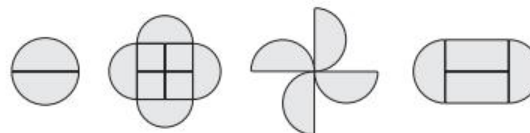

型号 Item#	桌面规格: cm Specification of desktop	高度: cm The height of desktop	颜色: Color
LTY - 195	120x60	50~56	桦木面、深灰边
LTY - 195-1	120x60	50~56	桦木面、米黄边

型号 Item#:

# 豪华型幼儿长方桌 LTY - 061

Luxury Kindergarten Rectangular Table



桌脚升降高度:  
Table foot lifting height.

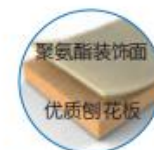
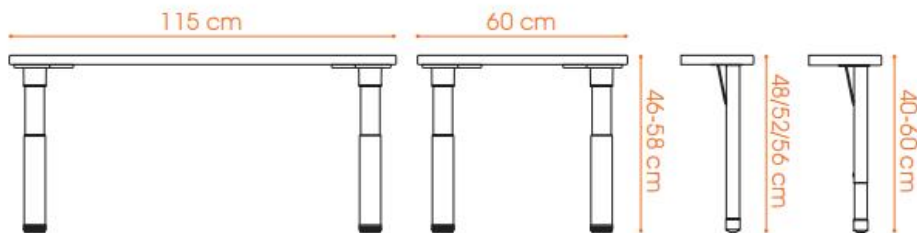

聚氨酯装饰面  
优质刨花板



全面升级 E0 级刨花板



板材可降解

## 包边颜色:

Edge color



## 桌面颜色:

Table top color

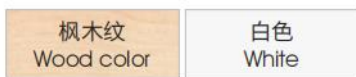

## 自由组合:

Free combination.

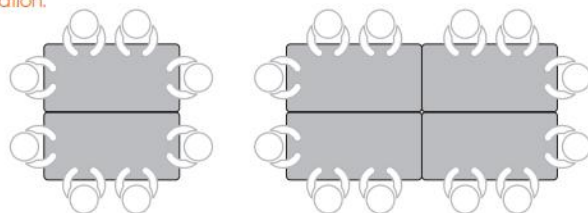

型号 Item#	桌面规格: cm Specification of desktop	高度: cm The height of desktop	桌面材料 Tabletop material.
LTY - 061	115x60	40-60	
LTY - 061	115x60	40-60	
LTY - 061-1-48	115x60	48	
LTY - 061-1-52	115x60	52	
LTY - 061-1-56	115x60	56	
LTY - 061-2	115x60	46-58	刨花板、注塑包边 Particle board Injection binging



利通貿易工程有限公司

LITTON TRADING & ENGINEERING LTD.

澳門宋玉生廣場, 258 建興龍廣場, 22樓H

ALAMEDA DR CARLOS D'ASSUMPCAO, 258, KIN HENG LONG PLAZA, 22H, Macau

Tel:2870 1830 Fax:2870 1630 E-mail: [info@kamslitton.com](mailto:info@kamslitton.com)

[www.kamslitton.com](http://www.kamslitton.com)

型号 Item#:

# 豪华型幼儿长方桌 LTY - 060-1

Luxury Kindergarten Rectangular Table

红色 Red LTY - 060

黄色 Yellow



桌脚升降高度:  
Table foot lifting height.

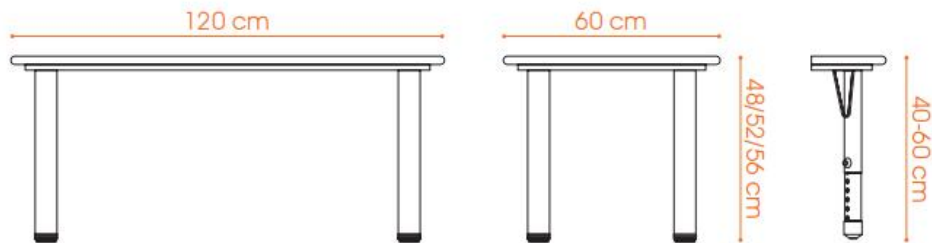

自由组合:  
Free combination.

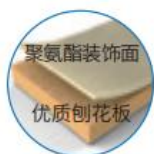
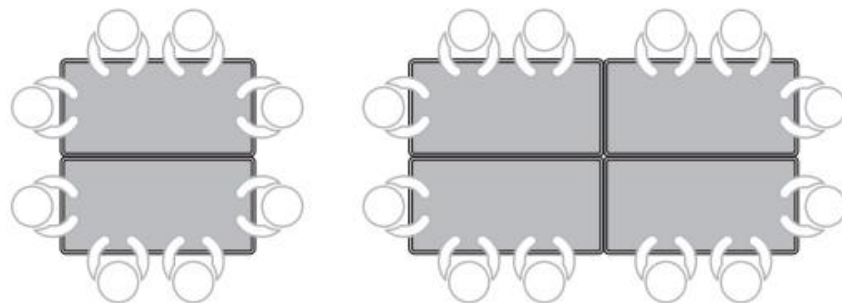

面板特殊定制 全面升级 E0 级刨花板 板材可降解

包边颜色:  
Edge color

红色 Red	橙黄色 Orange	黄色 Yellow
果绿色 Peak green	绿色 Green	蓝色 Blue
米黄色 Beige color		

桌面颜色:  
Table top color

枫木纹 Wood color	白色 White
----------------	----------

型号 Item#

桌面规格: cm  
Specification of desktop

高度: cm  
The height of desktop

桌面材料  
Tabletop material.

LTY - 060

120x60

48、52、56

刨花板、注塑包边

LTY - 060-1

120x60

40-60

Patide board Injection binging

型号 Item#:

# 豪华型幼儿正方桌 LTY - 071

Luxury Kindergarten Square Table



自由组合:  
Free combination.

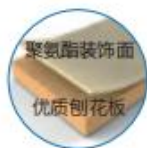
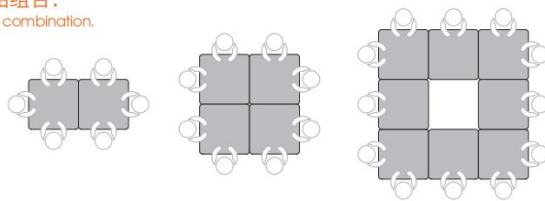

面板特殊定制



全面升级 E0 级刨花板



板材可降解



桌脚升降高度:  
Table foot lifting height.

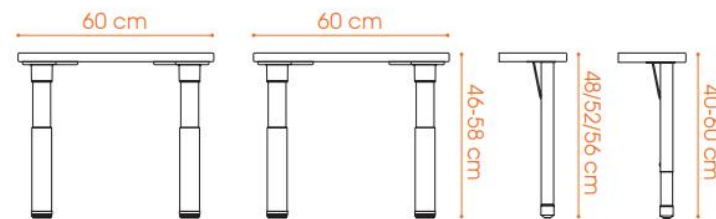

包边颜色:

Edge color

红色 Red	橙黄色 Orange	黄色 Yellow	
果绿色 Peak green	绿色 Green	蓝色 Blue	米黄色 Beige color

桌面颜色:

Table top color

枫木纹 Wood color	白色 White
-------------------	-------------

型号 Item#	桌面规格: cm Specification of desktop	高度: cm The height of desktop	桌面材料 Tabletop material.
LTY - 071	60x60	40-60	刨花板、注塑包边 Particle board Injection binging
LTY - 071	60x60	40-60	
LTY - 071-1-48	60x60	48	
LTY - 071-1-52	60x60	52	
LTY - 071-1-56	60x60	56	
LTY - 071-2	60x60	46-58	
LTY - 071-2B	60x60	46-58	

LTY - 071-2B 一套包装





型号 Item#:

# 可拼式儿童半月桌 LTY - 193

Combined Kid's Half-moon Table



可组合成不同的形状  
Could be combined into different shape

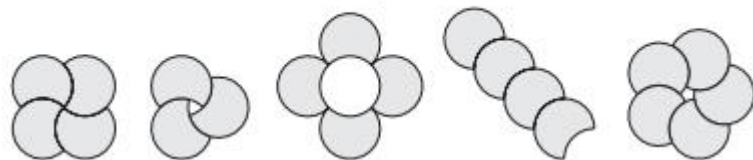

桌面颜色:  
Top color



榉木色  
Beech Color

包边颜色:  
Edge color



深灰色  
Dark Grey Color



米黄色  
Beige Color

型号 Item#

桌面规格: cm  
Specification of desktop

高度: cm  
The height of desktop

颜色  
Color

LTY - 193

90x75

50~56

榉木面、深灰边

LTY - 193-1

90x75

50~56

榉木面、米黄边

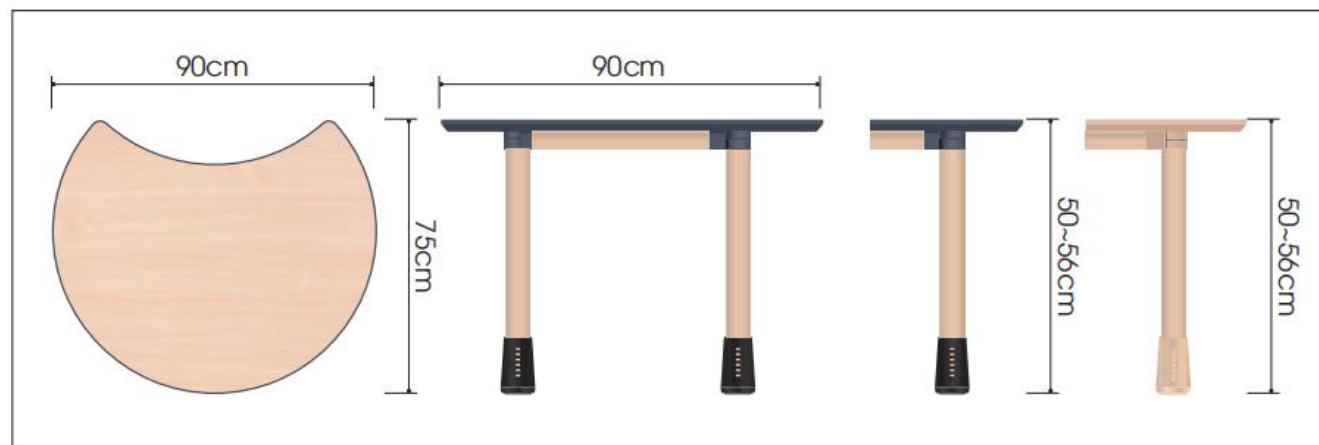

## 利通貿易工程有限公司

LITTON TRADING & ENGINEERING LTD.

澳門宋玉生廣場, 258 建興龍廣場, 22樓H

ALAMEDA DR CARLOS D'ASSUMPCAO, 258, KIN HENG LONG PLAZA, 22H, Macau

Tel:2870 1830 Fax:2870 1630 E-mail: [info@kamslitton.com](mailto:info@kamslitton.com)

[www.kamslitton.com](http://www.kamslitton.com)

型号 Item#:

# 可拼式儿童正方桌 LTY - 184

Combined Kid's Square Table



可组合成不同的形状  
Could be combined into different shape

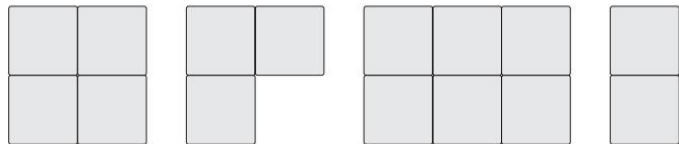

桌面颜色:  
Top color



桦木色  
Beech Color

包边颜色:  
Edge color



深灰色  
Dark Grey Color



米黄色  
Beige Color

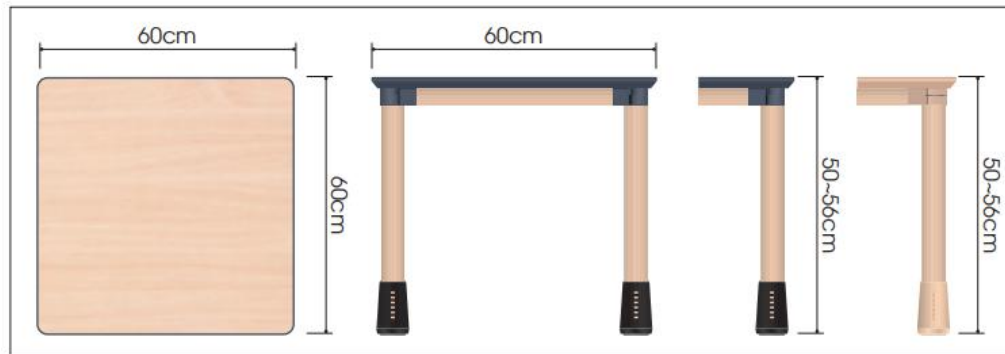

型号 Item#	桌面规格: cm Specification of desktop	高度: cm The height of desktop	颜色 Color
LTY - 184	60x60	50~56	桦木面、深灰边
LTY - 184-1	60x60	50~56	桦木面、米黄边

型号 Item#:

# 可拼式儿童梯形桌 LTY - 191

Combined Kid's Trapezoidal Table

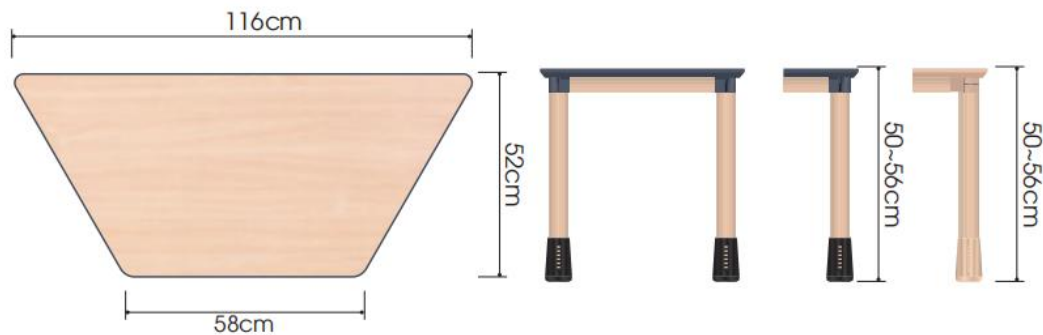

桌面颜色:  
Top color



包边颜色:  
Edge color



型号 Item#	桌面规格: cm Specification of desktop	高度: cm The height of desktop	颜色 Color
LTY - 191	116x52	50~56	桦木面、深灰边
LTY - 191-1	116x52	50~56	桦木面、米黄边

可组合成不同的形状  
Could be combined into different shape

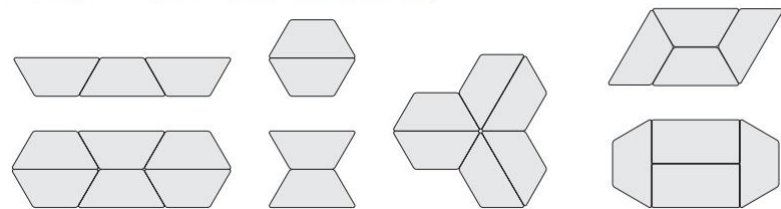

型号 Item#:

# 可拼式儿童三叶桌 LTY - 175

Combined Kid's Three-leaf Table



可组合成不同的形状  
Could be combined into different shape

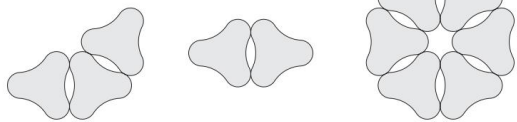

桌面颜色:  
Top color



榉木色  
Beech Color

包边颜色:  
Edge color



深灰色  
Dark Grey Color



米黄色  
Beige Color



型号 Item#	桌面规格: cm Specification of desktop	高度: cm The height of desktop	颜色 Color
LTY - 175	120x130	50~56	榉木面、深灰边
LTY - 175-1	120x130	50~56	榉木面、米黄边

**LITTON** 利通貿易工程有限公司  
LITTON TRADING & ENGINEERING LTD.

澳門宋玉生廣場, 258 建興龍廣場, 22樓H

ALAMEDA DR CARLOS D'ASSUMPCAO, 258, KIN HENG LONG PLAZA, 22H, Macau

Tel:2870 1830 Fax:2870 1630 E-mail: [info@kamslitton.com](mailto:info@kamslitton.com)

[www.kamslitton.com](http://www.kamslitton.com)

型号 Item#:

# 可拼式儿童长方桌 LTY - 183

Combined Kid's Rectangular Table

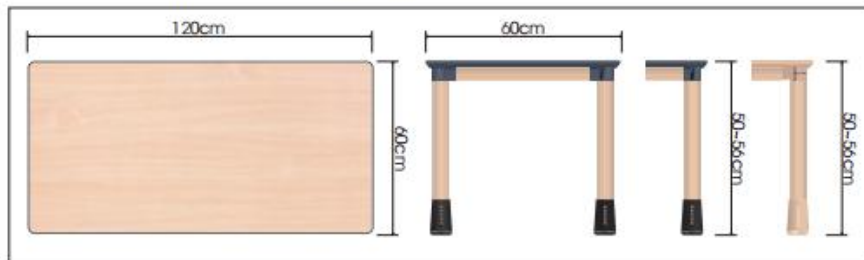
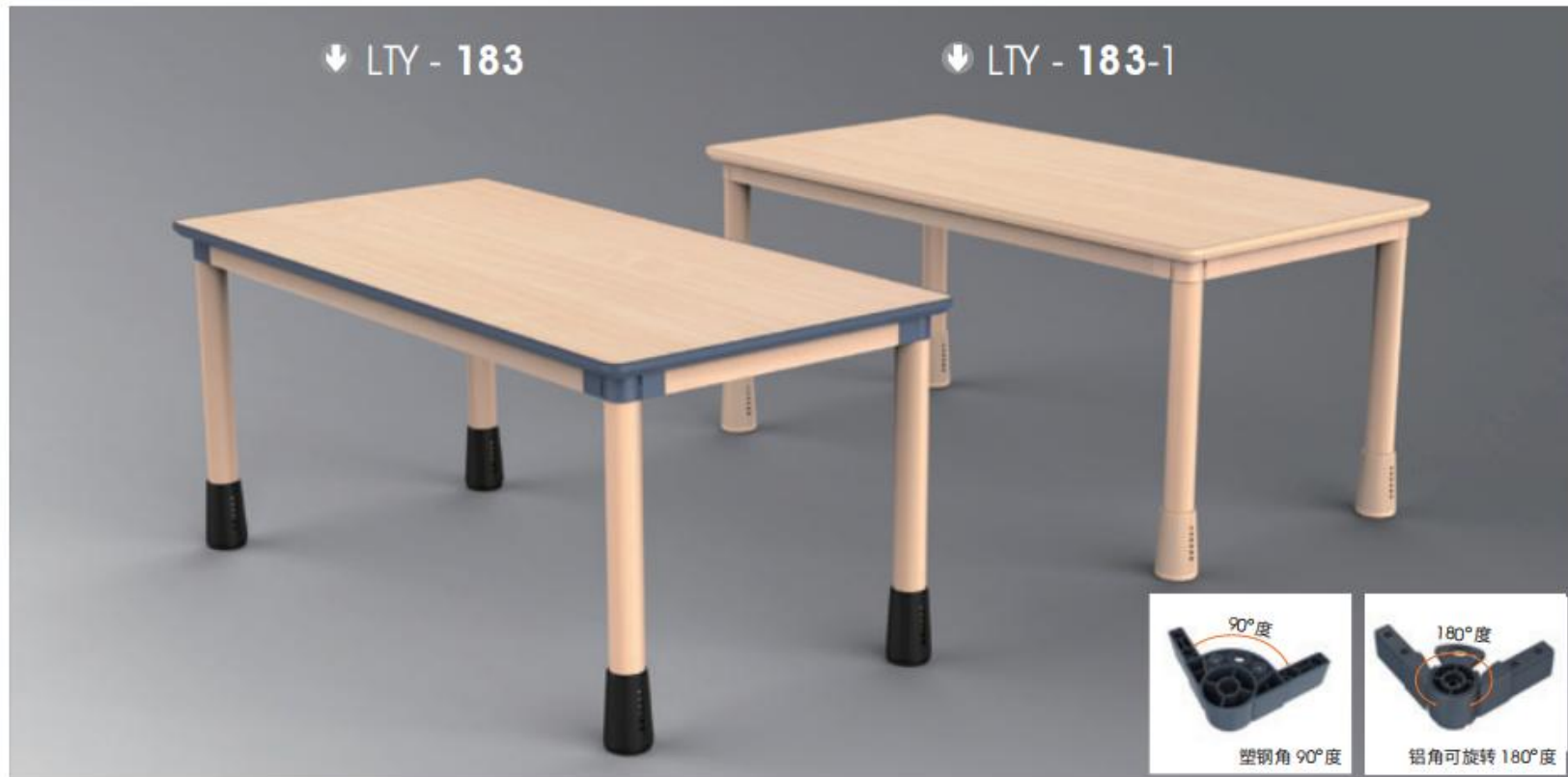

桌面颜色: Top color  
 榉木色 Beech Color

包边颜色: Edge color  
 深灰色 Dark Grey Color    米黄色 Beige Color

型号 Item#	桌面规格: cm Specification of desktop	高度: cm The height of desktop	颜色 Color
LTY - 183	120x60	50-56	榉木面、深灰边
LTY - 183-1	120x60	50-56	榉木面、米黄边

型号 Item#:

# 可拼式儿童长方桌 LTY - 185

Combined Kid's Rectangular Table



可组合成不同的形状

Could be combined into different shape

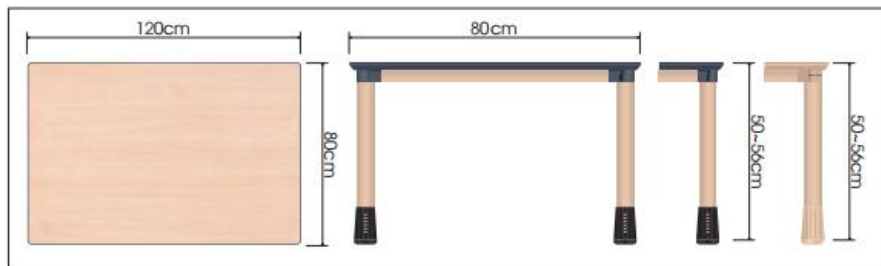
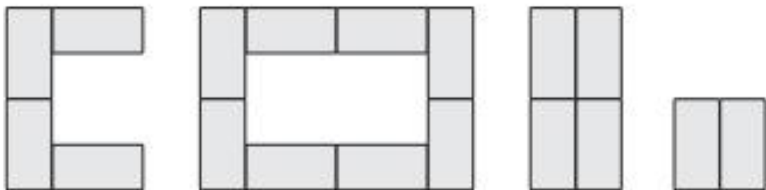

桌面颜色:  
Top color



包边颜色:  
Edge color

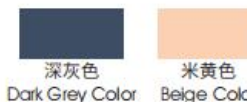

型号 Item#	桌面规格: cm Specification of desktop	高度: cm The height of desktop	颜色 Color
LTY - 185	120x80	50-56	榉木面、深灰边
LTY - 185-1	120x80	50-56	榉木面、米黄边

LITTON

利通貿易工程有限公司

LITTON TRADING & ENGINEERING LTD.

澳門宋玉生廣場, 258 建興龍廣場, 22樓H

ALAMEDA DR CARLOS D'ASSUMPCAO, 258, KIN HENG LONG PLAZA, 22H, Macau

Tel:2870 1830 Fax:2870 1630 E-mail: [info@kamslitton.com](mailto:info@kamslitton.com)

[www.kamslitton.com](http://www.kamslitton.com)

型号 Item#:

# 可拼式儿童圆桌 LTY - 192

Combined Kid's Rectangular Table



桌面颜色:  
Top color



榉木色  
Beech Color

包边颜色:  
Edge color



深灰色  
Dark Grey Color



米黄色  
Beige Color

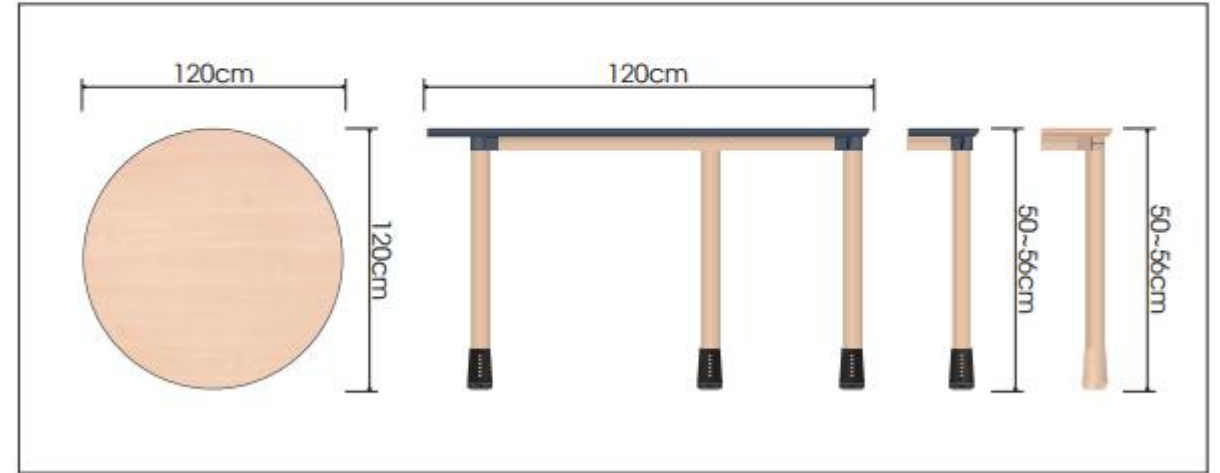

型号 Item#

LTY - 192

桌面规格: cm  
Specification of desktop

120x120

高度: cm  
The height of desktop

50~56

颜色  
Color

榉木面、深灰边

LITTON

利通貿易工程有限公司

LITTON TRADING & ENGINEERING LTD.

澳門宋玉生廣場, 258 建興龍廣場, 22樓H

ALAMEDA DR CARLOS D'ASSUMPCAO, 258, KIN HENG LONG PLAZA, 22H, Macau

Tel:2870 1830 Fax:2870 1630 E-mail: [info@kamslitton.com](mailto:info@kamslitton.com)

[www.kamslitton.com](http://www.kamslitton.com)

型号 Item#:

# 豪华型幼儿长方桌 LTY - 001

Luxurious Kid's rectangular table



## 特点:

桌面选用 PE 中空吹塑一次成型、经久耐用、不受气候温差影响而变形。边缘人性化设计, 具有防滑功能, 耐脏, 耐刮伤, 易清洗。桌脚可根据儿童身高及不平整地面自由调节高度。桌脚带有橡胶垫, 防止滑动和刮伤地板。安全, 易搬动。

型号 Item#	桌面规格: cm Specification of desktop	高度: cm The height of desktop	装箱数 Qty/ctn	外箱规格 cm Ctn size	净 / 毛重: kg N.W./G.W.
LTY - 001-2	122x62	40-60	1	123x63x5	11/12
LTY - 001-48	122x62	48			
LTY - 001-52	122x62	52	1	112x63x5.5	11/12
LTY - 001-56	122x62	56			
LTY - 001-1	122x62	48-60	1	112x63x5.5	11/12

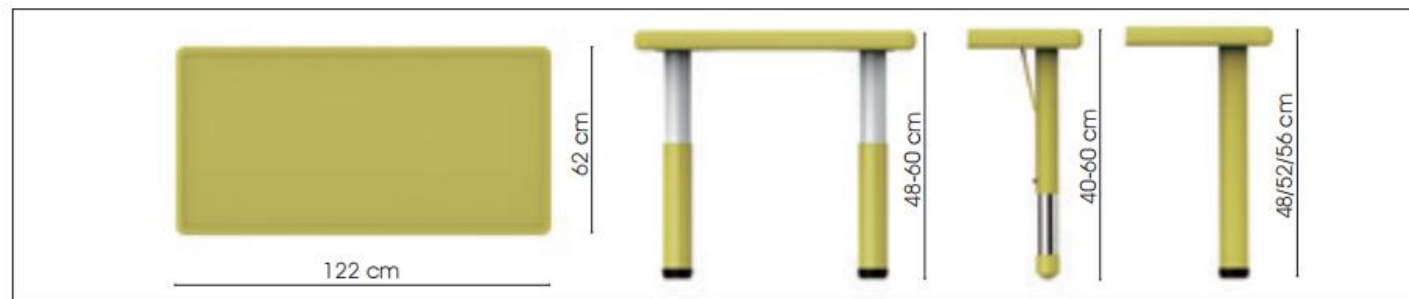

## 可选颜色:

Various color available



**LITTON** 利通貿易工程有限公司  
LITTON TRADING & ENGINEERING LTD.

澳門宋玉生廣場, 258 建興龍廣場, 22樓H

ALAMEDA DR CARLOS D'ASSUMPCAO, 258, KIN HENG LONG PLAZA, 22H, Macau

Tel:2870 1830 Fax:2870 1630 E-mail: [info@kamslitton.com](mailto:info@kamslitton.com)

[www.kamslitton.com](http://www.kamslitton.com)



型号 Item#:

# 豪华型幼儿正方桌 LTY - 002

Luxurious Kid's square table

↓ LTY - 002-1

↓ LTY - 002-2

↓ LTY - 002



型号 Item#	桌面规格: cm Specification of desktop	高度: cm The height of desktop	装箱数 Qty/ctn	外箱规格 cm Ctn size	净 / 毛重: kg N.W./G.W.
LTY - 002-2	62x62	40-60	1	64x63x5.5	8.5/9
LTY - 002-48	62x62	48			
LTY - 002-52	62x62	52	1	64x63x5	8/9
LTY - 002-56	62x62	56			
LTY - 002-1	62x62	48-60	1	64x63x5	7/8

## 特点:

桌面选用 PE 中空吹塑一次成型、经久耐用、不受气候温差影响而变形。  
边缘人性化设计, 具有防滑功能, 耐脏, 耐刮伤, 易清洗。  
桌脚可根据儿童身高及不平整地面自由调节高度。  
桌脚带有橡胶垫, 防止滑动和刮伤地板。  
安全, 易搬动。

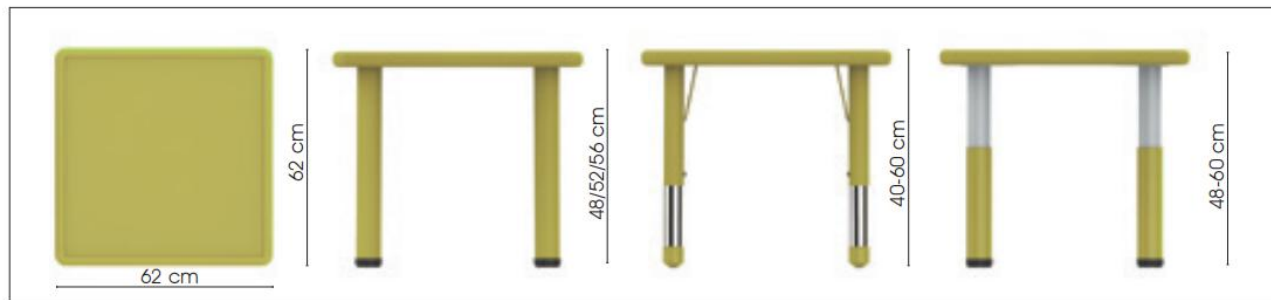

## 可选颜色:

Various color available

红色  
Red

橙黄色  
Orange

黄色  
Yellow

果绿色  
Peak green

绿色  
Green

蓝色  
Blue

宝蓝  
Royal Blue

**LITTON** 利通貿易工程有限公司  
LITTON TRADING & ENGINEERING LTD.

澳門宋玉生廣場, 258 建興龍廣場, 22樓H

ALAMEDA DR CARLOS D'ASSUMPCAO, 258, KIN HENG LONG PLAZA, 22H, Macau

Tel:2870 1830 Fax:2870 1630 E-mail: [info@kamslitton.com](mailto:info@kamslitton.com)

[www.kamslitton.com](http://www.kamslitton.com)

型号 Item#:

# 豪华型幼儿梯形桌 LTY - 003

Luxurious Kid's trapezoid table



Could be combined into different shape

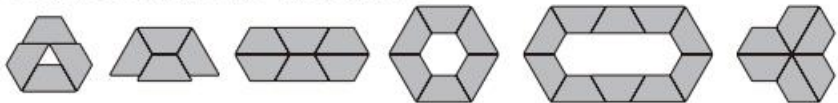

Blow-moulded table top  
吹塑桌面

型号 Item#	桌面规格: cm Specification of desktop	高度: cm The height of desktop	装箱数 Qty/ctn	外箱规格 cm Ctn size	净 / 毛重: kg N.W./G.W.
LTY - 003-2	122x61	40-60	1	123x63x5.5	11/12
LTY - 003-48	122x61	48			
LTY - 003-52	122x61	52	1	125x63x5	10.5/11.5
LTY - 003-56	122x61	56			
LTY - 003-1	122x61	48-60		125x63x5	9/10



可选颜色:

Various color available



**LITTON** 利通貿易工程有限公司  
LITTON TRADING & ENGINEERING LTD.

澳門宋玉生廣場, 258 建興龍廣場, 22樓H

ALAMEDA DR CARLOS D'ASSUMPCAO, 258, KIN HENG LONG PLAZA, 22H, Macau

Tel:2870 1830 Fax:2870 1630 E-mail: [info@kamslitton.com](mailto:info@kamslitton.com)

[www.kamslitton.com](http://www.kamslitton.com)

型号 Item#:

# 豪华型幼儿圆桌 LTY - 004

Luxurious Kid's Round table



可选颜色:

Various color available



型号 Item#	桌面规格: cm Specification of desktop	高度: cm The height of desktop	装箱数 Qty/ctn	外箱规格 cm Ctn size	净 / 毛重: kg N.W./G.W.
LTY - 004-2	115x115	40-60	1	116x116x5	15/16
LTY - 004-48	115x115	48			
LTY - 004-52	115x115	52	1	116x116x5	14.5/15.5
LTY - 004-56	115x115	56			
LTY - 004-1	115x115	48-60	1	116x116x5	13/14

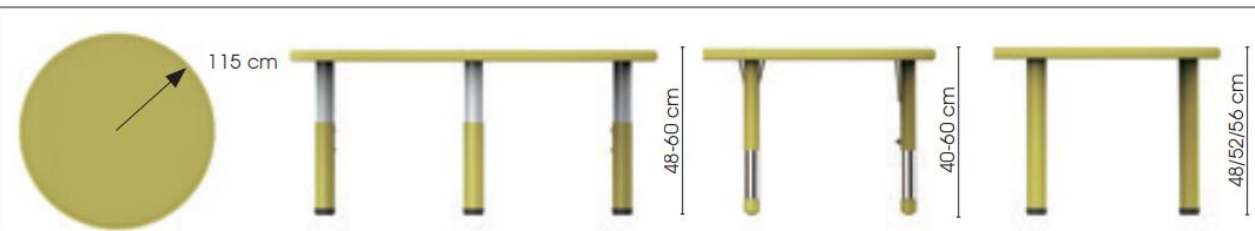

**LITTON** 利通貿易工程有限公司  
LITTON TRADING & ENGINEERING LTD.

澳門宋玉生廣場, 258 建興龍廣場, 22樓H  
ALAMEDA DR CARLOS D'ASSUMPCAO, 258, KIN HENG LONG PLAZA, 22H, Macau  
Tel:2870 1830 Fax:2870 1630 E-mail: [info@kamslitton.com](mailto:info@kamslitton.com)  
[www.kamslitton.com](http://www.kamslitton.com)

型号 Item#:

# 豪华型幼儿月亮桌 LTY - 005

Luxurious Kid's moon table



可选颜色:

Various color available



Blow-moulded table top  
吹塑桌面

型号 Item#	桌面规格: cm Specification of desktop	高度: cm The height of desktop	装箱数 Qty/ctn	外箱规格 cm Ctn size	净 / 毛重: kg N.W./G.W.
LTY - 005-2	165x90	40-60	1	167x91x5	16/17.5
LTY - 005-48	165x90	48			
LTY - 005-52	165x90	52	1	167x91x5	15.5/17
LTY - 005-56	165x90	56			
LTY - 005-1	165x90	48-60	1	167x91x5	14/15.5

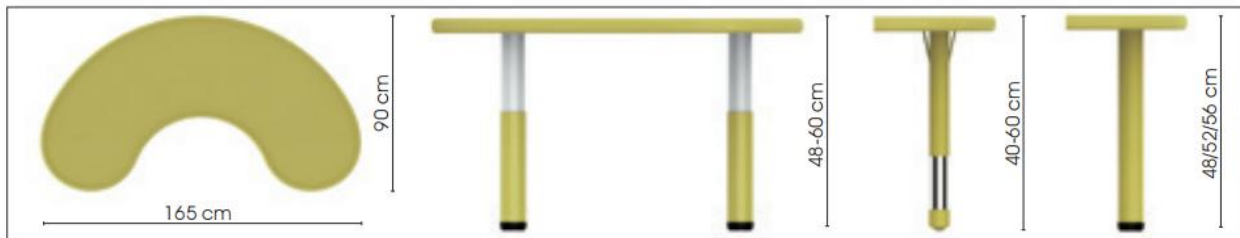

型号 Item#:

# 幼儿小圆桌 LTY - 007

Small round table for children

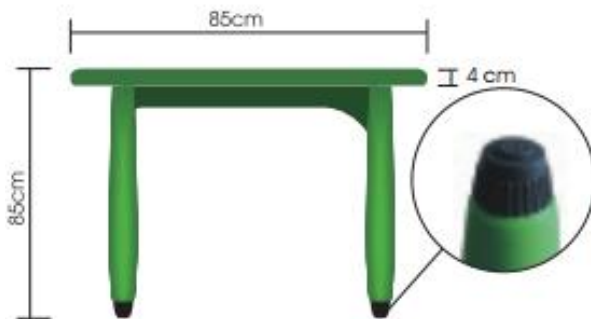

桌脚带有橡胶垫，防止滑动和刮伤地板

The table legs with rubber mat to avoid slipping and anti-scratch the floor.

桌面安装示意图  
Tabletop installation



可选颜色: Various color available.



## 型号 Item#: LTY - 007

规格: 85x85x52 cm  
Specification of table

装箱数: 1  
Qty/ctn

外箱规格: 86x86x12 cm  
Ctn size

净/毛重: 9/10.5kg  
N.W./G.W.

**LITTON** 利通貿易工程有限公司  
LITTON TRADING & ENGINEERING LTD.

澳門宋玉生廣場, 258 建興龍廣場, 22樓H

ALAMEDA DR CARLOS D'ASSUMPCAO, 258, KIN HENG LONG PLAZA, 22H, Macau

Tel:2870 1830 Fax:2870 1630 E-mail: [info@kamslitton.com](mailto:info@kamslitton.com)  
[www.kamslitton.com](http://www.kamslitton.com)

型号 Item#:

# 幼儿正方桌 LTY - 006

Square table for children

塑料腿

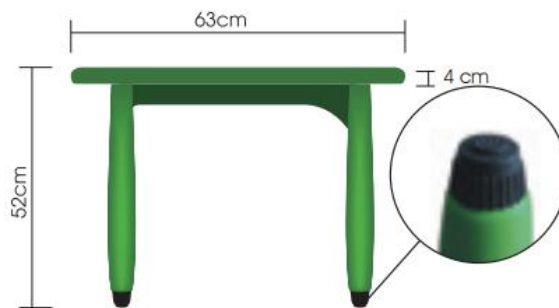

桌脚带有橡胶垫, 防止滑动和刮伤地板

The table legs with rubber mat to avoid slipping and anti-scratch the floor

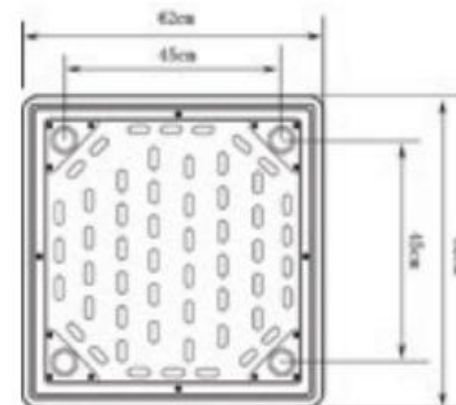

桌面安装示意图  
Tabletop installation



可选颜色: Various color available.

红色  
Red

橙黄色  
Orange

黄色  
Yellow

果绿色  
Peak green

绿色  
Green

蓝色  
Blue

## 型号 Item#: LTY - 006

规格: 62x62x52 cm  
Specification.

装箱数: 1  
Qty/ctn

外箱规格: 102x79x8 cm  
Ctn size

净/毛重: 7/8.5 kg  
N.W./G.W.

LITTON

利通貿易工程有限公司

LITTON TRADING & ENGINEERING LTD.

澳門宋玉生廣場, 258 建興龍廣場, 22樓H

ALAMEDA DR CARLOS D'ASSUMPCAO, 258, KIN HENG LONG PLAZA, 22H, Macau

Tel:2870 1830 Fax:2870 1630 E-mail: [info@kamslitton.com](mailto:info@kamslitton.com)

[www.kamslitton.com](http://www.kamslitton.com)

型号 Item#: **幼儿梅花桌 LTY - 050**  
 Plum blossom table for children  
 塑料腿

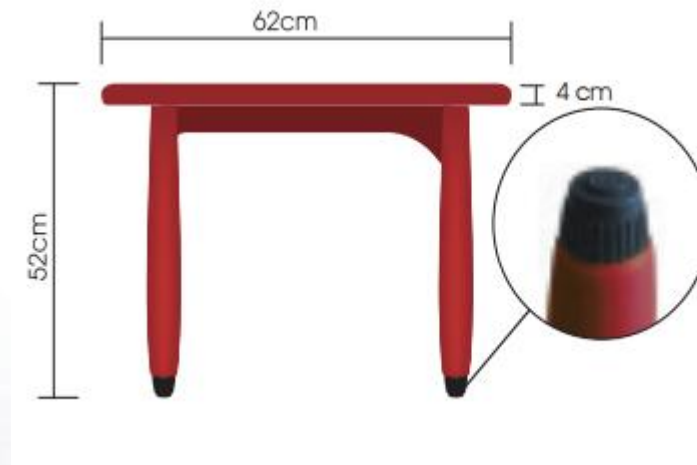

桌脚带有橡胶垫，防止滑动和刮伤地板

The table legs with rubber mat to avoid slipping and anti-scratch the floor.



可选颜色: Various color available.



型号 Item#: **LTY - 050**

规格: 62x62x52 cm  
Specification.

装箱数: 1  
Qty/ctn

外箱规格: 102x79x8 cm  
Ctn size

净 / 毛重: 5/6.5 kg  
N.W./G.W.

型号 Item#:

# 多功能組合雙人桌 LTY - 009

Luxurious Kid's moon table

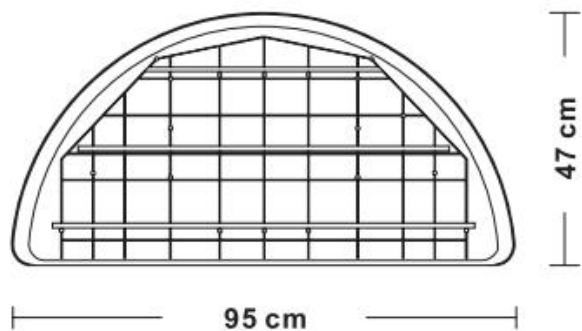

桌脚可升降调节 20cm  
It is adjustable 20 cm

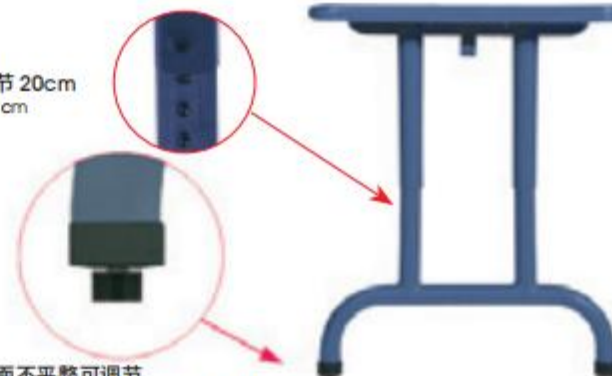

桌脚带有橡胶垫，地面不平整可调节  
The table legs with rubber mat, can be adjusted on uneven floor

可选颜色：  
Various color available



型号 Item#: LTY - 009

规格: 95x47x51-63 cm  
Specification:

桌面材料: ABS 注塑面板  
Desktop material: ABS injected board

桌脚材料: 喷塑脚  
Desk leg material: Powder coating leg

**LITTON** 利通貿易工程有限公司  
LITTON TRADING & ENGINEERING LTD.

澳門宋玉生廣場, 258 建興龍廣場, 22樓H

ALAMEDA DR CARLOS D'ASSUMPCAO, 258, KIN HENG LONG PLAZA, 22H, Macau

Tel:2870 1830 Fax:2870 1630 E-mail: [info@kamslitton.com](mailto:info@kamslitton.com)

[www.kamslitton.com](http://www.kamslitton.com)



型号 Item#:

# 多功能組合雙人桌 LTY - 009-1

Luxurious Kid's moon table



桌脚可升降调节 20cm  
It is adjustable 20 cm



桌脚带有橡胶垫，地面不平整可调节  
The table legs with rubber mat, can be adjusted on uneven floor

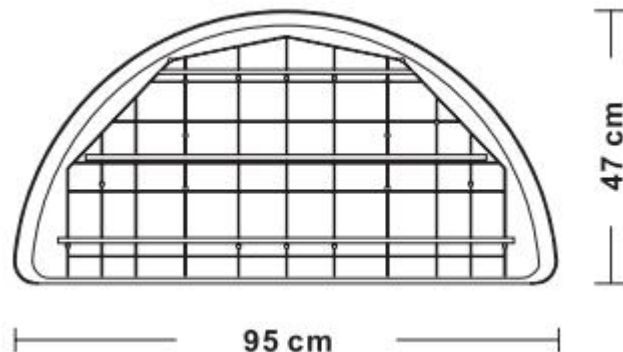

可选颜色:  
Various color available



## 型号 Item#: LTY - 009-1

规格: 95x47x51-63 cm  
Specification.

桌面材料: ABS 注塑面板  
Desktop material. ABS Injected board

桌脚材料: 电镀脚  
Deskleg material. Chromed leg

抽屉高度: 11 cm  
The height of drawer

**LITTON** 利通貿易工程有限公司  
LITTON TRADING & ENGINEERING LTD.

澳門宋玉生廣場, 258 建興龍廣場, 22樓H

ALAMEDA DR CARLOS D'ASSUMPCAO, 258, KIN HENG LONG PLAZA, 22H, Macau

Tel:2870 1830 Fax:2870 1630 E-mail: [info@kamslitton.com](mailto:info@kamslitton.com)  
[www.kamslitton.com](http://www.kamslitton.com)

# 现代学校多功能家具

Multipurpose furniture  
for modern school

## 幼儿椅系列



LTX - 000~007

座高: 24\30\28\26\33.5\35.5\40\44\44.5\46 cm  
The height of chairtop



LTX - 407D

座高: 46 cm  
The height of chairtop



LTX - 028

座高: 26\28\30\35\40 cm  
The height of chairtop



LTX - 305

座高: 31\36\40\46 cm  
The height of chairtop

# 现代学校多功能家具

**Multipurpose furniture**  
for modern school

## 幼儿椅系列



**LTX - 036**

座高：26/28/30 cm  
The height of chairtop



**LTX - 035**

座高：26~30 cm  
The height of chairtop



**LTX - 025**

座高：26\28\30 cm  
The height of chairtop

# 现代学校多功能家具

**Multipurpose furniture**  
for modern school

## 幼儿椅系列



**LTX - 026**

座高: 26\28\30 cm  
The height of chairtop



**LTX - 027**

座高: 26\28\30 cm  
The height of chairtop



**LTX - 801**

座高: 26~32 cm  
The height of chairtop

# 现代学校多功能家具

Multipurpose furniture  
for modern school

## 幼儿椅系列



LTX - 029

座高: 31/37/45/52 cm  
The height of chairtop



LTX - 129

座高: 28/30/34/40 cm  
The height of chairtop



LTX - 008~010

座高: 26.5/30.5/33.5 cm  
The height of chairtop

# 现代学校多功能家具

**Multipurpose furniture**  
for modern school

## 幼儿椅系列



**LTX - D01**

座高: 15\25\36 cm  
The height of chairtop



**LTX - D02**

座高: 39 cm  
The height of chairtop



**LTX - 128**

座高: 28 cm  
The height of chairtop

# LTX - 000...007



可选颜色:  
Various color available



椅子可叠加, 方便收藏

型号 Item#	规格 cm Specification	装箱数 Qty/ctn	外箱规格 cm Ctn size	净 / 毛重 kg N.W./G.W.
LTX - 000	41x25x24	10	90x30x27	9 / 11
LTX - 001	55x38x30	10	122x46x38	16.5 / 19
LTX - 002	53x36x28	10	117x43x38	15.5 / 18
LTX - 003	51x34x26	10	114x41x37	15 / 17
LTX - 004	58x38.5x33.5	10	141x47x39	20 / 22.5
LTX - 004-1	63x41.5x35.5	8	141x47x40	21 / 23.5
LTX - 005	70x44x40	5	116x53x46	15 / 18
LTX - 005-1	73.5x47x40	5	120x55x48	16.5 / 19.5
LTX - 006	76 x47x44	5	127x55x48	17 / 20
LTX - 006-1	79x51x44.5	5	127x57x50	18 / 21
LTX - 007	80x48x46	5	127x57x48	19.5 / 22

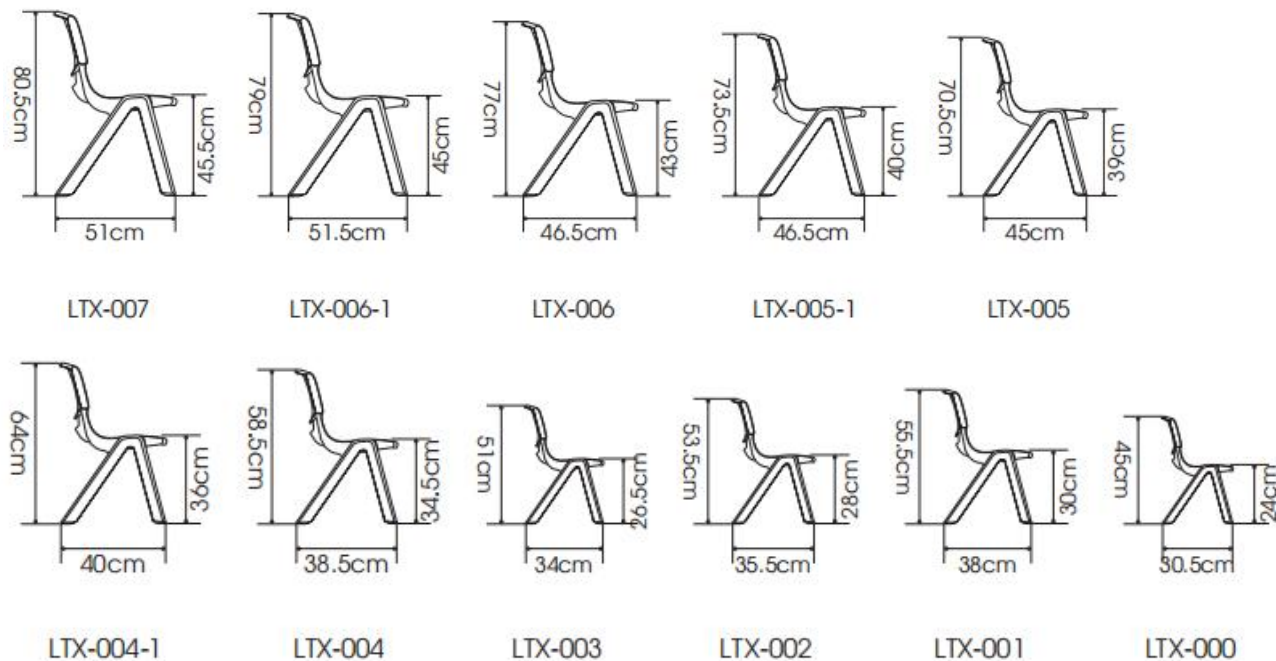

# LTX - 407D

豪华型塑料椅  
LUXURY PLASTIC CHAIR

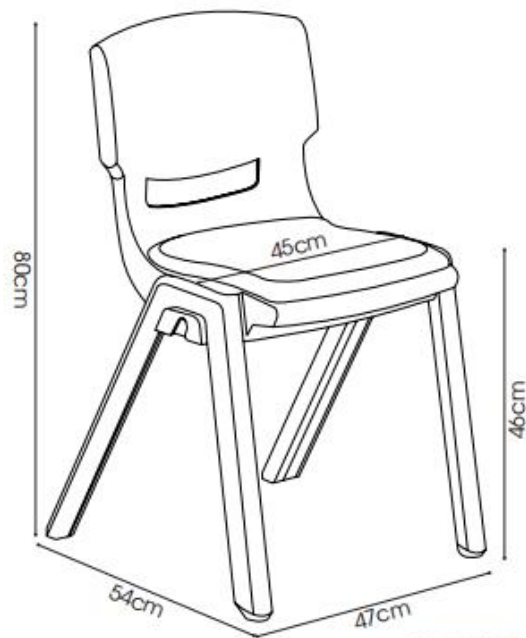

椅子结构尺寸图

Dimension diagram of the chair



椅子可叠加，方便收藏  
Chairs can be stacked and easy to store.

型号 Item#	规格 cm Specification	装箱数 Qty/ctn	外箱规格 cm Ctn size	净/毛重 kg N.W./G.W.
LTX - 407	80x54x46	5	129x58x50	20/23
LTX - 407D	80x54x46	5	129x58x50	22/25

可选颜色：  
Various color available



可将椅子坐板两边的子母扣轻松连接在一起示意图  
The buckles on both sides of the seat can be easily connected together according to a schematic diagram.

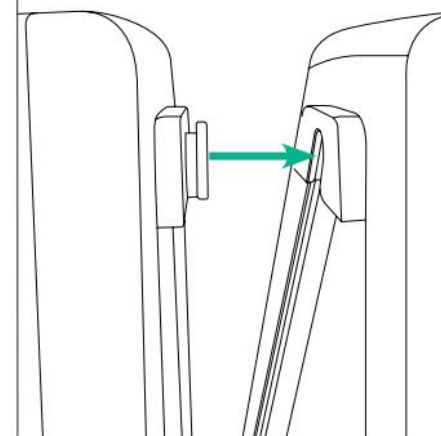



# LTX - 028

## 幼儿塑料太空椅 (2号)



正面



侧面



3/4 侧面

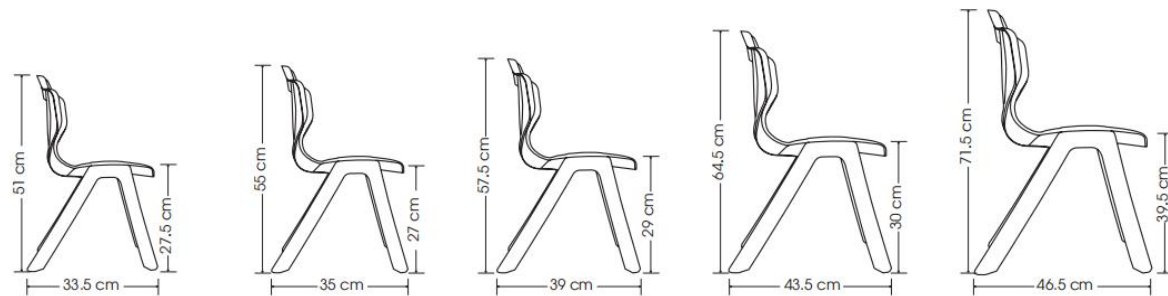

可选颜色:  
Various color available



型号 Item#	规格 cm Specification	装箱数 Qty/ctn	外箱规格 cm Ctn size	净 / 毛重 kg N.W./G.W.
LTX - 028-1	52x34x26	10	114x41x37	15 / 17
LTX - 028-2	56x35x28	10	117x43x38	15.5 / 18
LTX - 028-3	58x36.5x30	10	122x46x38	16.5 / 19
LTX - 028-4	65.5x42x35	10	141x47x39	20 / 22.5
LTX - 028-5	72x46.5x40	5	116x53x46	16.5 / 19



# LTX - 305 CC 塑料椅

CC PLASTIC CHAIR



可选颜色:  
Various color available

- 果绿色  
Peak green
- 绿色  
Green
- 蓝色  
Blue
- 红色  
Red
- 橙黄色  
Orange
- 黄色  
Yellow



型号 Item#	规格 cm Specification	装箱数 Qty/ctn	外箱规格 cm Ctn size	净 / 毛重 kg N.W./G.W.
LTX - 303	58x36x31	10	122x46x38	16.5/19
LTX - 304	64x43x36	8	141x49x41	17/19
LTX - 305	72x48x40	5	116x57x44	14.5/17
LTX - 307	82x55x46	5	127x60x49	23/23

# LTX - 036



可拆卸创意设计, 方便运输和存储  
Could be knocked down, save space convenient for transportation and stock

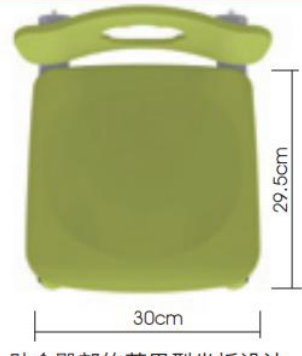

贴合臀部的苹果型坐板设计



软质脚套, 具有防滑静音功能

可选颜色:  
Various color available

- 果绿色 Peak green
- 绿色 Green
- 蓝色 Blue
- 红色 Red
- 橙黄色 Orange
- 黄色 Yellow

## LTX - 036-1



米黄色 Beige color



型号 Item#	规格 cm Specification	座高: cm Chairtop height.	材料: Chair material.
LTX - 036	30x30x51/53/55	26/28/30	PP 注塑 PP Injected board
LTX - 036-1	30x30x51/53/55	26/28/30	

# LTX - 035

## 可调节爱心椅



可拆卸创意设计, 方便运输和存储  
Could be knocked down,  
save space  
convenient for transportation  
and stock



贴合臀部的苹果型坐板设计

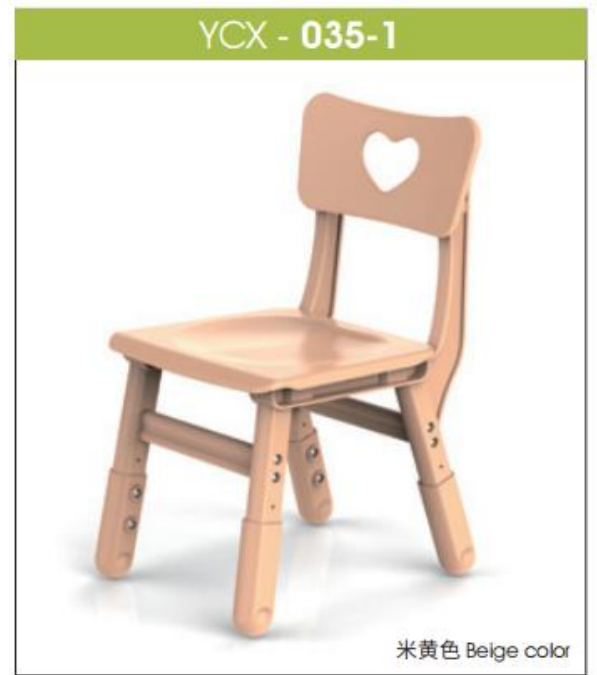

**特点:** 其坐垫及弹性靠背有助于儿童脊椎健康发育, 三种高度符合国家教委标准, 适合 3-8 岁儿童, 产品选用环保进口 PP 全新塑料, 注塑高压成型。产品质量不受气候温差影响, 经久耐用, 正常使用八年以上。防紫外线颜料, 鲜艳不褪色。产品可以拆装, 减少体积, 便于长途运输。

可选颜色:  
Various color available



型号 Item#	规格 cm Specification	座高: cm Chairtop height.	材料: Chair material.
LTX - 035	29.5x30x52/54/56	26/28/30	PP 注塑 PP injected board
LTX - 035-1	29.5x30x52/54/56	26/28/30	



# LTX - 025



**可选颜色:**  
Various color available



型号 Item#	规格 cm Specification	座高: cm Chairtop height.	材料: Chair material.	椅面颜色: Chair seat color.
LTX - 025-1	44x39x54	26	PP 注塑 PP injected board	红 / 黄 / 蓝 / 绿 / 橙 / 果绿 red / Yellow / Blue / Green / Orange / Peak green
LTX - 025-2	44x39x56	28		
LTX - 025-3	44x39x58	30		

**特点:** 最新研发的儿童椅, 其坐垫及弹性靠背有助于儿童脊椎健康发育, 三种高度符合国家教委标准, 适合 3-8 岁儿童, 产品选用环保进口 PP 全新塑料, 注塑高压成型。产品质量不受气候温差影响, 经久耐用, 正常使用八年以上。防紫外线颜料, 鲜艳不褪色。产品可以拆装, 减少体积, 便于长途运输。

# LTX - 026

## 可拆卸幼儿大嘴塑料椅



LTX - 026-3 大班      LTX - 026-2 中班      LTX - 026-1 小班



43cm      52cm/54cm/56cm

可拆卸创意设计, 方便运输和存储  
Could be knocked down, save space for transportation and stock



3 种尺寸可选  
Three size available



2cm  
2cm



**特点:** 最新研发的儿童椅, 其坐垫及弹性靠背有助于儿童脊椎健康发育, 三种高度符合国家教委标准, 适合 3-8 岁儿童, 产品选用环保进口 PP 全新塑料, 注塑高压成型。产品质量不受气候温差影响, 经久耐用, 正常使用八年以上。防紫外线颜料, 鲜艳不褪色。产品可以拆装, 减少体积, 便于长途运输。

型号 Item#	规格 cm Specification	座高: cm Chairtop height.	材料: Chair material.	椅面颜色: Chair seat color.
LTX - 026-1	44x39x50	26	PP 注塑 PP Injected board	红 / 黄 / 蓝 / 绿 / 橙 / 果绿 red / Yellow / Blue / Green / Orange / Peak green
LTX - 026-2	44x39x52	28		
LTX - 026-3	44x39x54	30		

# LTX - 027

LTX - 027-3 大班  
LTX - 027-2 中班  
LTX - 027-1 小班

可拆卸创意设计, 方便运输和存储  
Could be knocked down, save space for transportation and stock.

3 种尺寸可选  
Three size available

## 可拆装幼儿几何塑料椅 LTX - 027 Kid's chair



专利产品 仿冒必究  
Patented product counterfeit must investigate

型号 Item#	规格 cm Specification	座高: cm Chairtop height.	材料: Chair material.	椅面颜色: Chair seat color.
LTX - 027-1	44x39x50	26	PP 注塑 PP Injected board	红 / 黄 / 蓝 / 绿 / 橙 / 果绿 red / Yellow / Blue / Green / Orange / Peak green
LTX - 027-2	44x39x52	28		
LTX - 027-3	44x39x54	30		



# LTX - 029

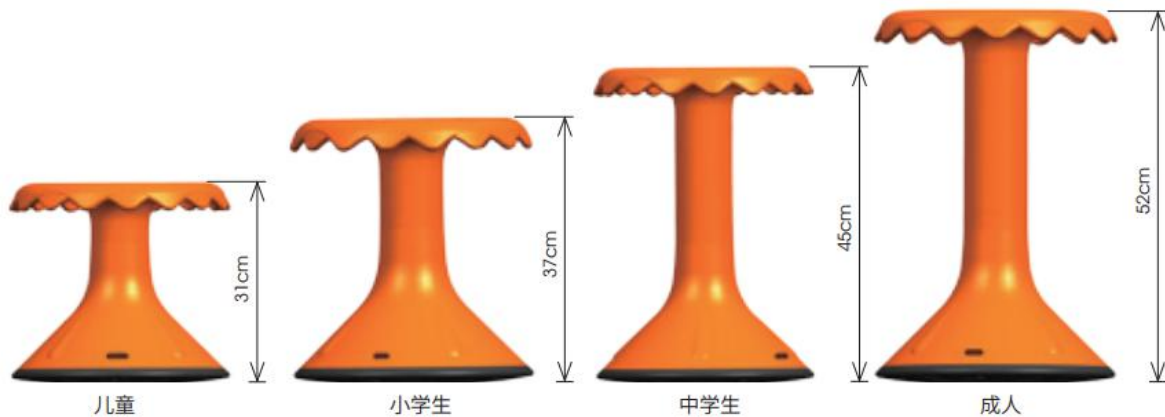

## 椅面可选颜色:

Various color available for chair.

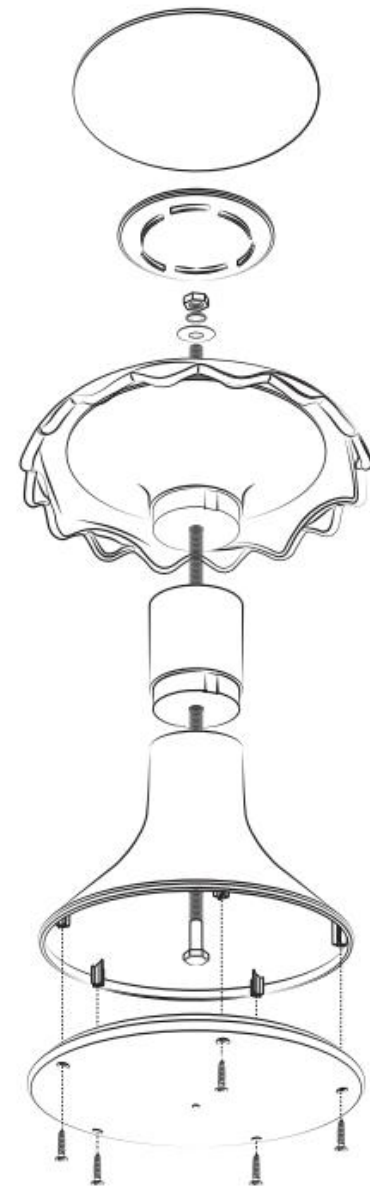
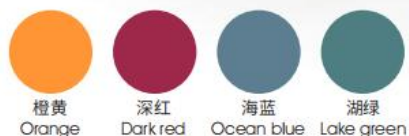

型号 Item#	椅子规格: Specification of chair	座高: Chairtop height.	椅面颜色: Chair color.
LTX - 029-1	33x33x31	31cm	
LTX - 029-2	33x33x37	37cm	
LTX - 029-3	33x33x45	45cm	深红 / 湖绿 / 海蓝 / 橙黄
LTX - 029-4	33x33x52	52cm	Dark red/Lake green /Ocean blue/Orange



# LTX - 129

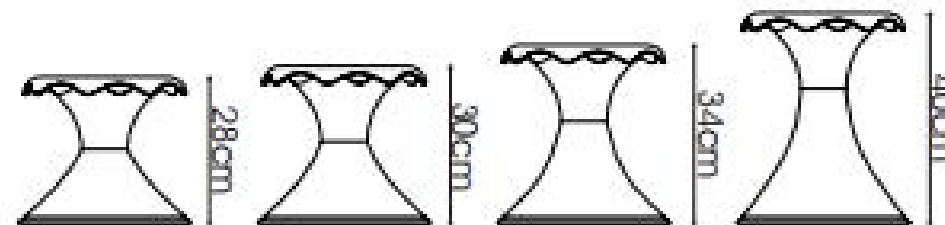
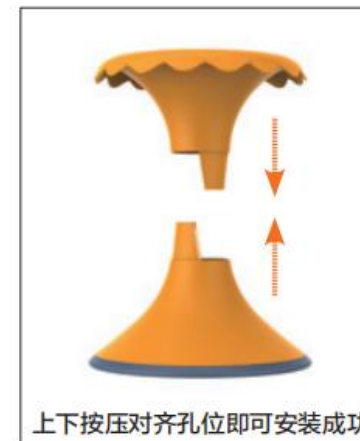
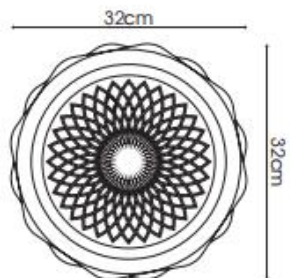

规格: cm Specification	座高: cm Chairtop height.	颜色: color.
26x26x28	28cm	
33x33x30	30cm	果绿、淡绿、橙黄、湖蓝、淡蓝、深红
33x33x34	34cm	
33x33x40	40cm	

拆装式葵花凳  
Disassembly sunflower stool

可选颜色:  
Different color available.



# LTX - 128



拼接方法示意图  
Assembly diagram

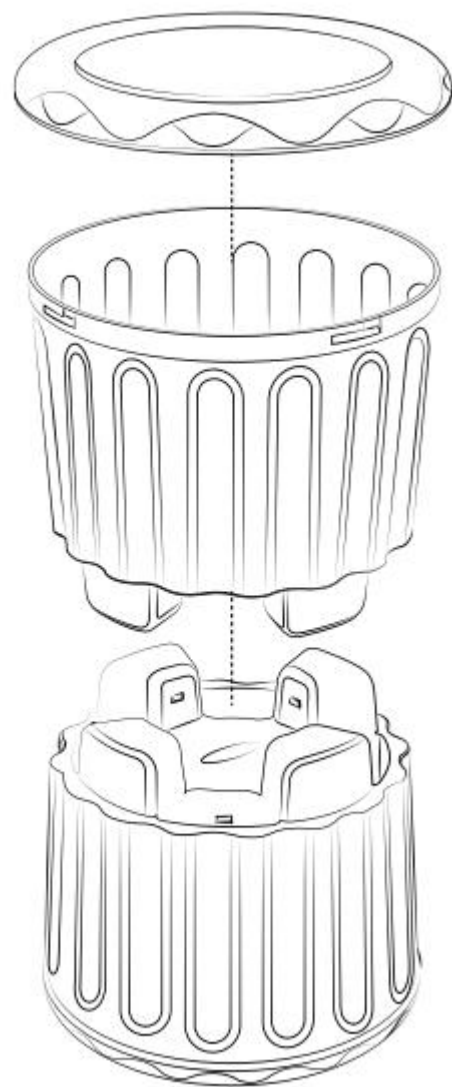

椅面可选颜色  
Different color available.



红色  
Red



黄色  
Yellow



橙黄色  
Orange



浅蓝色  
Light blue



果绿色  
Peak green



椅子规格:  
Specification of chair

33x33x28

座高:  
Chairtop height.

28cm

LITTON

利通貿易工程有限公司

LITTON TRADING & ENGINEERING LTD.

澳門宋玉生廣場, 258 建興龍廣場, 22樓H

ALAMEDA DR CARLOS D'ASSUMPCAO, 258, KIN HENG LONG PLAZA, 22H, Macau

Tel:2870 1830 Fax:2870 1630 E-mail: [info@kamslitton.com](mailto:info@kamslitton.com)

[www.kamslitton.com](http://www.kamslitton.com)

# LTX - D01



多角度翻转都可坐  
You can sit on multiple angles



## 椅面可选颜色:

Different color available.



深红色  
Dark Red

橙黄色  
Orange

浅蓝色  
Light blue

绿色  
Green

椅子规格: 36x36x36cm  
Specification of desk.

座高: 15/25/36cm  
Chairtop height.

椅子颜色: 红 / 橙 / 蓝 / 绿  
Chair color. Red / Orange / Blue / Green

# LTX - D02



椅子规格:  $\phi 37 \times 39 \text{cm}$   
Specification of desk.

座高: 39cm  
Chairtop height.

椅子颜色: 红 / 橙 / 蓝 / 绿  
Chair color. Red / Orange / Blue / Green

# LTX - 027



## 可选颜色:

Various Color available.

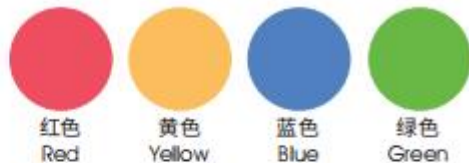

红色  
Red

黄色  
Yellow

蓝色  
Blue

绿色  
Green

型号 Item#

规格 cm  
Specification

LTX - 008 55x33x37xH26.5

LTX - 009 58x35x38xH30.5

LTX - 010 61x38x39xH33.5

# LTX - 012



## 椅面可选颜色:

Different color available.



深灰  
Dark grey



浅灰  
Light grey

型号 Item#

规格 cm  
Specification

LTX - 012-40 51x45x76xH40

LTX - 012-45 53x47x80xH45

LITTON

利通貿易工程有限公司

LITTON TRADING & ENGINEERING LTD.

澳門宋玉生廣場, 258 建興龍廣場, 22樓H

ALAMEDA DR CARLOS D'ASSUMPCAO, 258, KIN HENG LONG PLAZA, 22H, Macau

Tel:2870 1830 Fax:2870 1630 E-mail: [info@kamslitton.com](mailto:info@kamslitton.com)

[www.kamslitton.com](http://www.kamslitton.com)